



**SPECIFICATION SHEET**

<b>SPECIFICATION SHEET NO.</b>	R0109- MT02N3R9C500NI
<b>DATE</b>	Jan. 09, 2024
<b>REVISION</b>	A3
<b>DESCRIPTION</b>	Multilayer Ceramic Chip Capacitors MT0402 (1005 Metric) Series, L1.00*W0.50*H0.50mm, Thickness: 0.55mm Max. Dielectric NP0, Capacitance 3.9pF, Tolerance ±0.25pF, Rated Voltage 50V Operating Temp. Range -55°C ~+125°C Package in Tape/Reel, 10,000pcs/Reel RoHS/RoHS III compliant
<b>CUSTOMER</b>	
<b>CUSTOMER PART NUMBER</b>	
<b>CROSS REF. PART NUMBER</b>	
<b>ORIGINAL PART NUMBER</b>	Aillen/MT0402N3R9C500NI
<b>PART CODE</b>	MT02N3R9C500NI

<b>VENDOR APPROVE</b>			
Issued/Checked/Approved			
DATE: Jan. 09, 2024			

<b>CUSTOMER APPROVE</b>	
DATE:	

## MULTILAYER CERAMIC CHIP CAPACITORS MT SERIES

### MAIN FEATURE

MLCC consists of a conducting material and electrodes. To manufacture a chip-type SMT and achieve miniaturization, high density and high efficiency, ceramic condensers are used. MLCC is made by NP0, X7R, dielectric material and which provides product with high electrical precision, stability and reliability. Besides, MT series MLCC is tighten controlling in quality in line to assure quality performance in automotive applications.

### MAIN FEATURE

- RoHS III Compliant • The MT series meet AEC-Q200 requirement. • High capacitance in given case size
- A wide selection of sizes is available (0201 to 1210) • Capacitor with lead-free termination (pure Tin)

### APPLICATION

- For Navigation & Information equipments. • For entertainment equipments • For comfortable equipments
- For Automotive electronic equipment

**RFQ**  
Request For Quotation

### PART CODE GUIDE

Code	Name	Key Specification Option
<b>MT</b>	Product code	MT for Automotive safe concern (with AEC-Q200 qualification)
<b>02</b>	Size	0201 (0603): L0.60*W0.30mm; <b>0402 (1005): L1.00*W0.50mm</b> 0603 (1608): L1.60*W0.80mm; 0805 (2012): L2.00*W1.25mm 1206 (3216): L3.20*W1.60mm; 1210 (3225): L3.20*W2.50mm
<b>N</b>	Dielectric	<b>N: NP0 (COG); B: X7R;</b>
<b>3R9</b>	Capacitance	Two significant digits followed by number of Zero, The 3rd digit signifies the multiplying factor, and letter R is decimal point. 0R5: 0.5pF; <b>3R9:3.9pF</b> ; 152: 1500pF; 100: 10pF
<b>C</b>	Tolerance	B=±0.1pF; <b>C=±0.25pF</b> ; D=±0.5pF; F=±1%; G=±2%; J=±5%; K=±10%; M=±20%;
<b>500</b>	Rated Voltage	Two significant digits followed by No. of zeros. "R" is in place of decimal point. 100=10 VDC; 160=16 VDC; 250=25 VDC; <b>500=50 VDC</b> ; 101 =100 VDC; 201 =200 VDC; 251=250 VDC; 501 =500 VDC; 631 =630 VDC; 102 =1000 VDC;
<b>N</b>	Thickness	<b>N: 0.50±0.05mm, See Table 1</b>
<b>I</b>	Package	A: 1Kpcs/Reel; B: 2Kpcs/Reel; C: 3Kpcs/Reel; D: 4Kpcs/Reel; <b>I: 10Kpcs/Reel;</b> F: others
	Internal Control	Internal Code: Letter + Number; Blank: N/A;

**MULTILAYER CERAMIC CHIP CAPACITORS MT SERIES**

**DIMENSION (Unit: mm)**



Image for reference

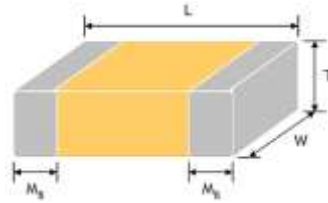

**Table 1**

Size Code	L	W	T (Symbol)		Remark	M B
0201 (0603)	0.60±0.03	0.30±0.03	0.3±0.03	L	#	0.15±0.05
0402 (1005)	1.00±0.05	0.50±0.05	0.50±0.05	N	#	0.25±0.05/-0.10
0603 (1608)	1.60±0.10	0.80±0.10	0.80±0.07	S		0.40±0.15
	1.60+0.15/-0.10	0.80+0.15/-0.10	0.80+0.15/-0.10	X		
0805 (2012)	2.00±0.15	1.25±0.10	0.60±0.10	A		0.50±0.20
			0.80±0.10	B		
			1.25±0.10	D	#	
	2.00±0.20	1.25±0.20	1.25±0.20	I	#	
1206 (3216)	3.20±0.15	1.60±0.15	0.80±0.10	B		0.60±0.20
			0.95±0.10	C		
			1.25±0.10	D	#	
	3.20±0.20	1.60±0.15	1.15±0.15	J	#	
	3.20±0.20	1.60±0.20	1.60±0.20	G	#	
	3.20+0.3/-0.1	1.60+0.3/-0.1	1.60+0.30/-0.10	P	#	
1210 (3225)	3.20±0.30	2.50±0.20	0.95±0.10	C	#	0.75±0.25
			1.25±0.10	D	#	
	3.20±0.40	2.50±0.30	1.60±0.20	G	#	
			2.00±0.20	K	#	
			2.50±0.30	M	#	

# Reflow soldering only is recommended.

1/9/2024

**MULTILAYER CERAMIC CHIP CAPACITORS MT SERIES**
**GENERAL ELECTRONICAL CHARACTERISTICS**
*Table 2*

<b>Dielectric</b>	NPO	X7R
<b>Size</b>	0201, 0402, 0603, 0805, 1206, 1210	0402, 0603, 0805, 1206
<b>Capacitance range*</b>	0.1pF to 0.047uF	100pF to 2.2uF
<b>Capacitance Tolerance</b>	5pF<Cap<10pF: B ( $\pm 0.1\text{pF}$ ), C ( $\pm 0.25\text{pF}$ ), D ( $\pm 0.5\text{pF}$ )	J ( $\pm 5\%$ ), K ( $\pm 10\%$ ), M ( $\pm 20\%$ )
<b>Rated Voltage</b>	10V, 16V, 25V, 50V, 100V, 200V, 250, 500, 630, 1000	
<b>Operating Temperature</b>	-55 ~+125°C	
<b>Capacitance Characteristic</b>	$\pm 30\text{ppm}$	$\pm 15\%$
<b>Termination</b>	Ni/Sn (lead-free termination)	

Note:

- 1) #1: NPO, 0.1pF product only provide B tolerance;
- 2) \* Measured at the condition of 30~70% related humidity.
- 3) NPO: Apply  $1.0\pm 0.2\text{Vrms}$ ,  $1.0\text{MHz}\pm 10\%$  for  $\text{Cap}\leq 1000\text{pF}$  and  $1.0\pm 0.2\text{Vrms}$ ,  $1.0\text{kHz}\pm 10\%$  for  $\text{Cap}>1000\text{pF}$ , 25°C at ambient temperature.
- 4) X7R: Measured at  $1.0\pm 0.2\text{Vrms}$ ,  $1.0\text{kHz}\pm 10\%$  for  $C\leq 10\mu\text{F}$ ;  $0.5\pm 0.2\text{Vrms}$ ,  $120\text{Hz}\pm 20\%$  for  $C>10\mu\text{F}$ , 30~70% related humidity, 25° C ambient temperature for X7R.
- 5) \*\* Preconditioning for Class II MLCC: Perform a heat treatment at  $150\pm 10^\circ\text{C}$  for 1 hour and then leave in ambient condition for  $24\pm 2$  hours before measurement.

**MULTILAYER CERAMIC CHIP CAPACITORS MT SERIES**

**CAPACITANCE RANGE - NP0 DIELECTRIC 0201, 0402 SIZES**

*Table 3-A*

Size	0201					0402				
	VDC (V)	10	16	25	50	100	10	16	25	50
0.1pF (0R1)	L	L	L	L	L	N	N	N	N	N
0.2pF (0R2)	L	L	L	L	L	N	N	N	N	N
0.3pF (0R3)	L	L	L	L	L	N	N	N	N	N
0.4pF (0R4)	L	L	L	L	L	N	N	N	N	N
0.5pF (0R5)	L	L	L	L	L	N	N	N	N	N
0.6pF (0R6)	L	L	L	L	L	N	N	N	N	N
0.7pF (0R7)	L	L	L	L	L	N	N	N	N	N
0.8pF (0R8)	L	L	L	L	L	N	N	N	N	N
0.9pF (0R9)	L	L	L	L	L	N	N	N	N	N
1.0pF (1R0)	L	L	L	L	L	N	N	N	N	N
1.2pF (1R2)	L	L	L	L	L	N	N	N	N	N
1.5pF (1R5)	L	L	L	L	L	N	N	N	N	N
1.8pF (1R8)	L	L	L	L	L	N	N	N	N	N
2.0pF (2R0)	L	L	L	L	L	N	N	N	N	N
2.2pF (2R2)	L	L	L	L	L	N	N	N	N	N
2.7pF (2R7)	L	L	L	L	L	N	N	N	N	N
3.0pF (3R0)	L	L	L	L	L	N	N	N	N	N
3.3pF (3R3)	L	L	L	L	L	N	N	N	N	N
3.9pF (3R9)	L	L	L	L	L	N	N	N	N	N
4.0pF (4R0)	L	L	L	L	L	N	N	N	N	N
4.7pF (4R7)	L	L	L	L	L	N	N	N	N	N
5.0pF (5R0)	L	L	L	L	L	N	N	N	N	N
5.6pF (5R6)	L	L	L	L	L	N	N	N	N	N
6.0pF (6R0)	L	L	L	L	L	N	N	N	N	N
6.8pF (6R8)	L	L	L	L	L	N	N	N	N	N
7.0pF (7R0)	L	L	L	L	L	N	N	N	N	N
8.0pF (8R0)	L	L	L	L	L	N	N	N	N	N
8.2pF (8R2)	L	L	L	L	L	N	N	N	N	N
9.0pF (9R0)	L	L	L	L	L	N	N	N	N	N
10pF (100)	L	L	L	L	L	N	N	N	N	N
12pF (120)	L	L	L	L	L	N	N	N	N	N
15pF (150)	L	L	L	L	L	N	N	N	N	N
18pF (180)	L	L	L	L	L	N	N	N	N	N
22pF (220)	L	L	L	L	L	N	N	N	N	N
27pF (270)	L	L	L	L	L	N	N	N	N	N

**MULTILAYER CERAMIC CHIP CAPACITORS MT SERIES**

**CAPACITANCE RANGE - NPO DIELECTRIC 0201, 0402 SIZES**

*Table 3-B*

Size	0201					0402				
VDC (V)	10	16	25	50	100	10	16	25	50	100
33pF (330)	L	L	L	L	L	N	N	N	N	N
39pF (390)	L	L	L	L	L	N	N	N	N	N
47pF (470)	L	L	L	L	L	N	N	N	N	N
56pF (560)	L	L	L	L	L	N	N	N	N	N
68pF (680)	L	L	L	L	L	N	N	N	N	N
82pF (820)	L	L	L	L	L	N	N	N	N	N
100pF (101)	L	L	L	L	L	N	N	N	N	N
120pF (121)	L	L	L	L	L	N	N	N	N	N
150pF (151)						N	N	N	N	N
180pF (181)						N	N	N	N	N
220pF (221)						N	N	N	N	N
270pF (271)						N	N	N	N	
330pF (331)						N	N	N	N	
390pF (391)						N	N	N	N	
470pF (471)						N	N	N	N	
560pF (561)						N	N	N	N	
680pF (681)						N	N	N	N	
820pF (821)						N	N	N	N	
1,000pF (102)						N	N	N	N	

**CAPACITANCE RANGE - NPO DIELECTRIC 0603 SIZES**

*Table 3-C*

Size	0603						
VDC (V)	10	16	25	50	100	200	250
0.5pF (0R5)	S	S	S	S	S	S	S
0.6pF (0R6)	S	S	S	S	S	S	S
0.7pF (0R7)	S	S	S	S	S	S	S
0.8pF (0R8)	S	S	S	S	S	S	S
0.9pF (0R9)	S	S	S	S	S	S	S
1.0pF (1R0)	S	S	S	S	S	S	S
1.2pF (1R2)	S	S	S	S	S	S	S
1.5pF (1R5)	S	S	S	S	S	S	S
1.8pF (1R8)	S	S	S	S	S	S	S
2.0pF (2R0)	S	S	S	S	S	S	S

**MULTILAYER CERAMIC CHIP CAPACITORS MT SERIES**

**CAPACITANCE RANGE - NP0 DIELECTRIC 0603 SIZES**

*Table 3-D*

Size	0603						
VDC (V)	10	16	25	50	100	200	250
2.2pF (2R2)	S	S	S	S	S	S	S
2.7pF (2R7)	S	S	S	S	S	S	S
3.0pF (3R0)	S	S	S	S	S	S	S
3.3pF (3R3)	S	S	S	S	S	S	S
3.9pF (3R9)	S	S	S	S	S	S	S
4.0pF (4R0)	S	S	S	S	S	S	S
4.7pF (4R7)	S	S	S	S	S	S	S
5.0pF (5R0)	S	S	S	S	S	S	S
5.6pF (5R6)	S	S	S	S	S	S	S
6.0pF (6R0)	S	S	S	S	S	S	S
6.8pF (6R8)	S	S	S	S	S	S	S
7.0pF (7R0)	S	S	S	S	S	S	S
8.0pF (8R0)	S	S	S	S	S	S	S
8.2pF (8R2)	S	S	S	S	S	S	S
9.0pF (9R0)	S	S	S	S	S	S	S
10pF (100)	S	S	S	S	S	S	S
12pF (120)	S	S	S	S	S	S	S
15pF (150)	S	S	S	S	S	S	S
18pF (180)	S	S	S	S	S	S	S
22pF (220)	S	S	S	S	S	S	S
27pF (270)	S	S	S	S	S	S	S
33pF (330)	S	S	S	S	S	S	S
39pF (390)	S	S	S	S	S	S	S
47pF (470)	S	S	S	S	S	S	S
56pF (560)	S	S	S	S	S	S	S
68pF (680)	S	S	S	S	S	S	S
82pF (820)	S	S	S	S	S	S	S
100pF (101)	S	S	S	S	S	S	S
120pF (121)	S	S	S	S	S	S	S
150pF (151)	S	S	S	S	S	S	S
180pF (181)	S	S	S	S	S	S	S
220pF (221)	S	S	S	S	S	S	S
270pF (271)	S	S	S	S	S	X	X
330pF (331)	S	S	S	S	S	X	X
390pF (391)	S	S	S	S	S	X	X

**MULTILAYER CERAMIC CHIP CAPACITORS MT SERIES**
**CAPACITANCE RANGE - NPO DIELECTRIC 0603 SIZES**
*Table 3-E*

Size	0603						
VDC (V)	10	16	25	50	100	200	250
470pF (471)	S	S	S	S	S	X	X
560pF (561)	S	S	S	S	S		
680pF (681)	S	S	S	S	S		
820pF (821)	S	S	S	S	S		
1,000pF (102)	S	S	S	S	S		
1,200pF (122)	X	X	X	X			
1,500pF (152)	X	X	X	X			
1,800pF (182)	X	X	X	X			
2,200pF (222)	X	X	X	X			
2,700pF (272)	X	X	X	X			
3,300pF (332)	X	X	X	X			

**CAPACITANCE RANGE - NPO DIELECTRIC 0805 SIZES**
*Table 3-F*

Size	0805								
VDC (V)	10	16	25	50	100	200	250	500	630
0.5pF (0R5)	A	A	A	A	A	A	A	A	A
0.6pF (0R6)	A	A	A	A	A	A	A	A	A
0.7pF (0R7)	A	A	A	A	A	A	A	A	A
0.8pF (0R8)	A	A	A	A	A	A	A	A	A
0.9pF (0R9)	A	A	A	A	A	A	A	A	A
1.0pF (1R0)	A	A	A	A	A	A	A	A	A
1.2pF (1R2)	A	A	A	A	A	A	A	A	A
1.5pF (1R5)	A	A	A	A	A	A	A	A	A
1.8pF (1R8)	A	A	A	A	A	A	A	A	A
2.2pF (2R2)	A	A	A	A	A	A	A	A	A
2.7pF (2R7)	A	A	A	A	A	A	A	A	A
3.3pF (3R3)	A	A	A	A	A	A	A	A	A
3.9pF (3R9)	A	A	A	A	A	A	A	A	A
4.7pF (4R7)	A	A	A	A	A	A	A	A	A
5.6pF (5R6)	A	A	A	A	A	A	A	A	A
6.8pF (6R8)	A	A	A	A	A	A	A	A	A
8.2pF (8R2)	A	A	A	A	A	A	A	A	A



**MULTILAYER CERAMIC CHIP CAPACITORS MT SERIES**

**CAPACITANCE RANGE - NPO DIELECTRIC 0805 SIZES**

*Table 3-G*

Size	0805								
VDC (V)	10	16	25	50	100	200	250	500	630
10pF (100)	A	A	A	A	A	A	A	A	A
12pF (120)	A	A	A	A	A	A	A	A	A
15pF (150)	A	A	A	A	A	A	A	A	A
18pF (180)	A	A	A	A	A	A	A	A	A
22pF (220)	A	A	A	A	A	A	A	A	A
27pF (270)	A	A	A	A	A	A	A	A	A
33pF (330)	A	A	A	A	A	A	A	A	A
39pF (390)	A	A	A	A	A	A	A	A	A
47pF (470)	A	A	A	A	A	A	A	A	A
56pF (560)	A	A	A	A	A	A	A	A	A
68pF (680)	A	A	A	A	A	A	A	A	A
82pF (820)	A	A	A	A	A	A	A	B	B
100pF (101)	A	A	A	A	A	B	B	B	B
120pF (121)	A	A	A	A	A	B	B	D	D
150pF (151)	A	A	A	A	A	D	D	D	D
180pF (181)	A	A	A	A	A	D	D	D	D
220pF (221)	A	A	A	A	A	D	D	D	D
270pF (271)	A	A	A	A	A	D	D	D	D
330pF (331)	A	A	A	A	A	D	D	D	D
390pF (391)	B	B	A	A	A	D	D	D	D
470pF (471)	B	B	B	B	B	D	D	I	I
560pF (561)	B	B	B	B	B	D	D	I	I
680pF (681)	B	B	B	B	B	D	D	I	I
820pF (821)	B	B	B	B	B	D	D	I	I
1,000pF (102)	B	B	B	B	B	D	D	I	I
1,200pF (122)	B	B	B	B	B	D	D		
1,500pF (152)	B	B	B	B	B	D	D		
1,800pF (182)	B	B	B	B	B	D	D		
2,200pF (222)	B	B	B	B	B	D	D		
2,700pF (272)	D	D	D	D	D				
3,300pF (332)	D	D	D	D	D				
3,900pF (392)	D	D	D	D	D				
4,700pF (472)	D	D	D	D	D				
5,600pF (562)	D	D	D	D	D				
6,800pF (682)	D	D	D	D	D				
8,200pF (822)	D	D	D	D					
0.01μF (103)	D	D	D	D					

**MULTILAYER CERAMIC CHIP CAPACITORS MT SERIES**

**CAPACITANCE RANGE - NP0 DIELECTRIC 1206**

*Table 3-H*

Size	1206									
VDC (V)	10	16	25	50	100	200	250	500	630	1000
1.2pF (1R2)	B	B	B	B	B	B	B	B	B	
1.5pF (1R5)	B	B	B	B	B	B	B	B	B	B
1.8pF (1R8)	B	B	B	B	B	B	B	B	B	B
2.2pF (2R2)	B	B	B	B	B	B	B	B	B	B
2.7pF (2R7)	B	B	B	B	B	B	B	B	B	B
3.3pF (3R3)	B	B	B	B	B	B	B	B	B	B
3.9pF (3R9)	B	B	B	B	B	B	B	B	B	B
4.7pF (4R7)	B	B	B	B	B	B	B	B	B	B
5.6pF (5R6)	B	B	B	B	B	B	B	B	B	B
6.8pF (6R8)	B	B	B	B	B	B	B	B	B	B
8.2pF (8R2)	B	B	B	B	B	B	B	B	B	B
10pF (100)	B	B	B	B	B	B	B	B	B	B
12pF (120)	B	B	B	B	B	B	B	B	B	B
15pF (150)	B	B	B	B	B	B	B	B	B	B
18pF (180)	B	B	B	B	B	B	B	B	B	B
22pF (220)	B	B	B	B	B	B	B	B	B	D
27pF (270)	B	B	B	B	B	B	B	B	B	D
33pF (330)	B	B	B	B	B	B	B	B	B	D
39pF (390)	B	B	B	B	B	B	B	B	B	D
47pF (470)	B	B	B	B	B	B	B	B	B	D
56pF (560)	B	B	B	B	B	B	B	B	B	D
68pF (680)	B	B	B	B	B	B	B	B	B	D
82pF (820)	B	B	B	B	B	B	B	B	B	D
100pF (101)	B	B	B	B	B	B	B	B	B	D
120pF (121)	B	B	B	B	B	B	B	B	B	D
150pF (151)	B	B	B	B	B	B	B	B	B	D
180pF (181)	B	B	B	B	B	B	B	B	B	G
220pF (221)	B	B	B	B	B	B	B	B	B	G
270pF (271)	B	B	B	B	B	B	C	C	C	G
330pF (331)	B	B	B	B	B	B	C	C	C	G
390pF (391)	B	B	B	B	B	B	C	C	C	G
470pF (471)	B	B	B	B	B	C	C	C	C	G
560pF (561)	B	B	B	B	B	C	D	D	D	G
680pF (681)	B	B	B	B	B	C	D	D	D	G
820pF (821)	B	B	B	B	B	C	G	G	G	G

**MULTILAYER CERAMIC CHIP CAPACITORS MT SERIES**

**CAPACITANCE RANGE - NPO DIELECTRIC 1206 SIZES**

*Table 3-I*

Size	1206									
VDC (V)	10	16	25	50	100	200	250	500	630	1000
1,000pF (102)	B	B	B	B	B	C	G	G	G	G
1,200pF (122)	B	B	B	B	B	C	G	G	G	
1,500pF (152)	B	B	B	B	B	D	G	G	G	
1,800pF (182)	B	B	B	B	B	D	G	G	G	
2,200pF (222)	B	B	B	B	B	D	G	G	G	
2,700pF (272)	B	B	B	B	B	D	G	G	G	
3,300pF (332)	B	B	B	B	B	D	G	G	G	
3,900pF (392)	B	B	B	B	B	D	G	G	G	
4,700pF (472)	B	B	B	B	B	D	G	G	G	
5,600pF (562)	B	B	B	B	B					
6,800pF (682)	C	C	C	C	C					
8,200pF (822)	D	D	D	D	D					
0.01μF (103)	D	D	D	D	D					

**CAPACITANCE RANGE - NPO DIELECTRIC 1210 SIZES**

*Table 3-J*

Size	1210									
VDC (V)	10	16	25	50	100	200	250	500	630	1000
10pF (100)	C	C	C	C	C	C	C	C	C	C
12pF (120)	C	C	C	C	C	C	C	C	C	C
15pF (150)	C	C	C	C	C	C	C	C	C	C
18pF (180)	C	C	C	C	C	C	C	C	C	C
22pF (220)	C	C	C	C	C	C	C	C	C	C
27pF (270)	C	C	C	C	C	C	C	C	C	C
33pF (330)	C	C	C	C	C	C	C	C	C	C
39pF (390)	C	C	C	C	C	C	C	C	C	C
47pF (470)	C	C	C	C	C	C	C	C	C	C
56pF (560)	C	C	C	C	C	C	C	C	C	C
68pF (680)	C	C	C	C	C	C	C	C	C	C
82pF (820)	C	C	C	C	C	C	C	C	C	C
100pF (101)	C	C	C	C	C	C	C	C	C	D
120pF (121)	C	C	C	C	C	C	C	C	C	D
150pF (151)	C	C	C	C	C	C	C	C	C	D
180pF (181)	C	C	C	C	C	C	C	C	C	D
220pF (221)	C	C	C	C	C	C	C	C	C	G

**MULTILAYER CERAMIC CHIP CAPACITORS MT SERIES**

**CAPACITANCE RANGE - NP0 DIELECTRIC 1210 SIZES**

*Table 3-K*

Size	1210									
VDC (V)	10	16	25	50	100	200	250	500	630	1000
270pF (271)	C	C	C	C	C	C	C	C	C	G
330pF (331)	C	C	C	C	C	C	C	C	C	G
390pF (391)	C	C	C	C	C	C	C	C	C	G
470pF (471)	C	C	C	C	C	C	C	C	C	G
560pF (561)	C	C	C	C	C	C	C	C	C	G
680pF (681)	C	C	C	C	C	C	C	C	C	G
820pF (821)	C	C	C	C	C	C	C	C	C	G
1,000pF (102)	C	C	C	C	C	D	D	D	D	G
1,200pF (122)	C	C	C	C	C	D	D	D	D	
1,500pF (152)	C	C	C	C	C	D	D	D	D	
1,800pF (182)	C	C	C	C	C	D	D	D	D	
2,200pF (222)	C	C	C	C	C	D	D	D	D	
2,700pF (272)	C	C	C	C	C	D	D	D	D	
3,300pF (332)	C	C	C	C	C	D	D	D	D	
3,900pF (392)	C	C	C	C	C	D	D	D	D	
4,700pF (472)	C	C	C	C	C	G	G			
5,600pF (562)	C	C	C	C	C	G	G			
6,800pF (682)	C	C	C	C	C	G	G			
8,200pF (822)	C	C	C	C	C	G	G			
0.010μF (103)	C	C	C	C	C	G	G			
0.012μF (123)	D	D	D	D	D					
0.015μF (153)	D	D	D	D	D					
0.018μF (183)	K	K	K	K	K					
0.022μF (223)	K	K	K	K	K					
0.027μF (273)	K	K	K	K	K					
0.033μF (333)	K	K	K	K	K					
0.039μF (393)	K	K	K	K	K					
0.047μF (473)	K	K	K	K	K					

**MULTILAYER CERAMIC CHIP CAPACITORS MT SERIES**

**CAPACITANCE RANGE – X7R DIELECTRIC 0201, 0402 SIZES**

*Table 4-A*

Size	0201				0402			
VDC (V)	10	16	25	50	10	16	25	50
100pF (101)	L	L	L	L	N	N	N	N
120pF (121)	L	L	L	L	N	N	N	N
150pF (151)	L	L	L	L	N	N	N	N
180pF (181)	L	L	L	L	N	N	N	N
220pF (221)	L	L	L	L	N	N	N	N
270pF (271)	L	L	L	L	N	N	N	N
330pF (331)	L	L	L	L	N	N	N	N
390pF (391)	L	L	L	L	N	N	N	N
470pF (471)	L	L	L	L	N	N	N	N
560pF (561)	L	L	L	L	N	N	N	N
680pF (681)	L	L	L	L	N	N	N	N
820pF (821)	L	L	L	L	N	N	N	N
1,000pF (102)	L	L	L	L	N	N	N	N
1,200pF (122)	L	L	L		N	N	N	N
1,500pF (152)	L	L	L		N	N	N	N
1,800pF (182)	L	L	L		N	N	N	N
2,200pF (222)	L	L	L		N	N	N	N
2,700pF (272)	L	L	L		N	N	N	N
3,300pF (332)	L	L	L		N	N	N	N
3,900pF (392)	L	L	L		N	N	N	N
4,700pF (472)	L	L	L		N	N	N	N
5,600pF (562)	L	L	L		N	N	N	N
6,800pF (682)	L				N	N	N	N
8,200pF (822)	L				N	N	N	N
0.010μF (103)	L				N	N	N	N
0.012μF (123)					N	N	N	
0.015μF (153)					N	N	N	
0.018μF (183)					N	N	N	
0.022μF (223)					N	N	N	
0.027μF (273)					N	N	N	
0.033μF (333)					N	N	N	
0.039μF (393)					N	N	N	
0.047μF (473)					N	N	N	
0.056μF (563)					N	N	N	
0.068μF (683)					N	N	N	
0.082μF (823)					N	N	N	
0.10μF (104)					N	N	N	

**MULTILAYER CERAMIC CHIP CAPACITORS MT SERIES**

**CAPACITANCE RANGE – X7R DIELECTRIC 0603 SIZES**

*Table 4-B*

Size	0603				
	10	16	25	50	100
VDC (V)					
100pF (101)	S	S	S	S	S
120pF (121)	S	S	S	S	S
150pF (151)	S	S	S	S	S
180pF (181)	S	S	S	S	S
220pF (221)	S	S	S	S	S
270pF (271)	S	S	S	S	S
330pF (331)	S	S	S	S	S
390pF (391)	S	S	S	S	S
470pF (471)	S	S	S	S	S
560pF (561)	S	S	S	S	S
680pF (681)	S	S	S	S	S
820pF (821)	S	S	S	S	S
1,000pF (102)	S	S	S	S	S
1,200pF (122)	S	S	S	S	S
1,500pF (152)	S	S	S	S	S
1,800pF (182)	S	S	S	S	S
2,200pF (222)	S	S	S	S	S
2,700pF (272)	S	S	S	S	S
3,300pF (332)	S	S	S	S	S
3,900pF (392)	S	S	S	S	S
4,700pF (472)	S	S	S	S	S
5,600pF (562)	S	S	S	S	S
6,800pF (682)	S	S	S	S	S
8,200pF (822)	S	S	S	S	S
0.010μF (103)	S	S	S	S	S
0.012μF (123)	S	S	S	S	X
0.015μF (153)	S	S	S	S	X
0.018μF (183)	S	S	S	S	X
0.022μF (223)	S	S	S	S	X
0.027μF (273)	S	S	S	S	X
0.033μF (333)	S	S	S	X	X
0.039μF (393)	S	S	S	X	X
0.047μF (473)	S	S	S	X	X
0.056μF (563)	S	S	S	X	
0.068μF (683)	S	S	S	X	

**MULTILAYER CERAMIC CHIP CAPACITORS MT SERIES**

**CAPACITANCE RANGE – X7R DIELECTRIC 0603 SIZES**

*Table 4-C*

Size	0603				
VDC (V)	10	16	25	50	100
0.082µF (823)	S	S	S	X	
0.10µF (104)	S	S	S	X	
0.12µF (124)	X	X	X		
0.15µF (154)	X	X	X	X	
0.18µF (184)	X	X	X		
0.22µF (224)	X	X	X	X	
0.33µF (334)	X	X	X	X	

**CAPACITANCE RANGE – X7R DIELECTRIC 0805 SIZES**

*Table 4-D*

Size	0805								
VDC (V)	10	16	25	50	100	200	250	500	630
100pF (101)	B	B	B	B	B	B	B	B	B
120pF (121)	B	B	B	B	B	B	B	B	B
150pF (151)	B	B	B	B	B	B	B	B	B
180pF (181)	B	B	B	B	B	B	B	B	B
220pF (221)	B	B	B	B	B	B	B	B	B
270pF (271)	B	B	B	B	B	B	B	B	B
330pF (331)	B	B	B	B	B	B	B	B	B
390pF (391)	B	B	B	B	B	B	B	B	B
470pF (471)	B	B	B	B	B	B	B	B	B
560pF (561)	B	B	B	B	B	B	B	B	B
680pF (681)	B	B	B	B	B	B	B	B	B
820pF (821)	B	B	B	B	B	B	B	B	B
1,000pF (102)	B	B	B	B	B	B	B	B	B
1,200pF (122)	B	B	B	B	B	B	B	B	B
1,500pF (152)	B	B	B	B	B	B	B	B	B
1,800pF (182)	B	B	B	B	B	B	B	B	B
2,200pF (222)	B	B	B	B	B	B	B	B	B
2,700pF (272)	B	B	B	B	B	B	B	B	B
3,300pF (332)	B	B	B	B	B	B	B	B	B
3,900pF (392)	B	B	B	B	B	B	B	B	B
4,700pF (472)	B	B	B	B	B	B	B	D	D

**MULTILAYER CERAMIC CHIP CAPACITORS MT SERIES**

**CAPACITANCE RANGE – X7R DIELECTRIC 0805 SIZES**

*Table 4-E*

Size	0805								
VDC (V)	10	16	25	50	100	200	250	500	630
5,600pF (562)	B	B	B	B	B	B	B	D	D
6,800pF (682)	B	B	B	B	B	B	B	D	D
8,200pF (822)	B	B	B	B	B	B	B	D	D
0.010μF (103)	B	B	B	B	B	D	D	D	D
0.012μF (123)	B	B	B	B	B	D	D		
0.015μF (153)	B	B	B	B	B	D	D		
0.018μF (183)	B	B	B	B	B	D	D		
0.022μF (223)	B	B	B	B	B	D	D		
0.027μF (273)	B	B	B	B	B				
0.033μF (333)	B	B	B	B	B				
0.039μF (393)	B	B	B	B	B				
0.047μF (473)	B	B	B	B	B				
0.056μF (563)	B	B	B	B	B				
0.068μF (683)	B	B	B	B	D				
0.082μF (823)	B	B	B	B	D				
0.10μF (104)	B	B	B	B	D				
0.12μF (124)	B	B	B	D					
0.15μF (154)	D	D	D	D					
0.18μF (184)	D	D	D	D					
0.22μF (224)	D	D	D	D					
0.27μF (274)	D	D	D	I					
0.33μF (334)	D	D	D	I					
0.39μF (394)	D	D	D	I					
0.47μF (474)	D	D	D	I					
0.56μF (564)	D	D	D						
0.68μF (684)	D	D	D	I					
0.82μF (824)	D	D	D						
1.0μF (105)	D	D	D	I					

**CAPACITANCE RANGE – X7R DIELECTRIC 1206 SIZES**

*Table 4-F*

Size	1206								
VDC (V)	10	16	25	50	100	200	250	500	630
100pF (101)						D	D	D	D
120pF (121)						D	D	D	D
150pF (151)	B	B	B	B	B	D	D	D	D
180pF (181)	B	B	B	B	B	D	D	D	D



**MULTILAYER CERAMIC CHIP CAPACITORS MT SERIES**

**CAPACITANCE RANGE – X7R DIELECTRIC 1206 SIZES**

*Table 4-G*

Size	1206								
VDC (V)	10	16	25	50	100	200	250	500	630
220pF (221)	B	B	B	B	B	D	D	D	D
270pF (271)	B	B	B	B	B	D	D	D	D
330pF (331)	B	B	B	B	B	D	D	D	D
390pF (391)	B	B	B	B	B	D	D	D	D
470pF (471)	B	B	B	B	B	D	D	D	D
560pF (561)	B	B	B	B	B	D	D	D	D
680pF (681)	B	B	B	B	B	D	D	D	D
820pF (821)	B	B	B	B	B	D	D	D	D
1,000pF (102)	B	B	B	B	B	D	D	D	D
1,200pF (122)	B	B	B	B	B	D	D	D	D
1,500pF (152)	B	B	B	B	B	D	D	D	D
1,800pF (182)	B	B	B	B	B	D	D	D	D
2,200pF (222)	B	B	B	B	B	D	D	D	D
2,700pF (272)	B	B	B	B	B	D	D	D	D
3,300pF (332)	B	B	B	B	B	D	D	D	D
3,900pF (392)	B	B	B	B	B	D	D	D	D
4,700pF (472)	B	B	B	B	B	D	D	D	D
5,600pF (562)	B	B	B	B	B	D	D	D	D
6,800pF (682)	B	B	B	B	B	D	D	D	D
8,200pF (822)	B	B	B	B	B	D	D	D	D
0.010μF (103)	B	B	B	B	B	D	D	D	D
0.012μF (123)	B	B	B	B	B	D	D		
0.015μF (153)	B	B	B	B	B	D	D		
0.018μF (183)	B	B	B	B	B	D	D		
0.022μF (223)	B	B	B	B	B	D	D		
0.027μF (273)	B	B	B	B	B				
0.033μF (333)	B	B	B	B	B				
0.039μF (393)	B	B	B	B	B				
0.047μF (473)	B	B	B	B	B				
0.056μF (563)	B	B	B	B	B				
0.068μF (683)	B	B	B	B	B				
0.082μF (823)	B	B	B	B	D				
0.10μF (104)	B	B	B	B	D				
0.12μF (124)	B	B	B	B	D				
0.15μF (154)	C	C	C	C	G				
0.18μF (184)	C	C	C	C	G				

**MULTILAYER CERAMIC CHIP CAPACITORS MT SERIES**

**CAPACITANCE RANGE – X7R DIELECTRIC 1206 SIZES**

*Table 4-H*

Size	1206								
VDC (V)	10	16	25	50	100	200	250	500	630
0.22µF (224)	C	C	C	C	G				
0.27µF (274)	C	C	C	D					
0.33µF (334)	C	C	C	D					
0.39µF (394)	C	C	J	P					
0.47µF (474)	J	J	J	P					
0.56µF (564)	J	J	J	P					
0.68µF (684)	J	J	J	P					
0.82µF (824)	J	J	J	P					
1.0µF (105)	J	J	J	P					

**CAPACITANCE RANGE – X7R DIELECTRIC 1210 SIZES**

*Table 4-I*

Size	1210							
VDC (V)	10	16	25	50	100	250	500	1000
100pF (101)						D	D	D
120pF (121)						D	D	D
150pF (151)						D	D	D
180pF (181)						D	D	D
220pF (221)						D	D	D
270pF (271)						D	D	D
330pF (331)						D	D	D
390pF (391)						D	D	D
470pF (471)						D	D	D
560pF (561)						D	D	D
680pF (681)						C	D	D
820pF (821)						C	D	D
1,000pF (102)	C	C	C	C	C	C	D	D
1,200pF (122)	C	C	C	C	C	C	D	D
1,500pF (152)	C	C	C	C	C	C	D	D
1,800pF (182)	C	C	C	C	C	C	D	D
2,200pF (222)	C	C	C	C	C	C	D	D
2,700pF (272)	C	C	C	C	C	C	D	D
3,300pF (332)	C	C	C	C	C	C	D	D
3,900pF (392)	C	C	C	C	C	C	D	G
4,700pF (472)	C	C	C	C	C	C	D	G
5,600pF (562)	C	C	C	C	C	C	D	G

**MULTILAYER CERAMIC CHIP CAPACITORS MT SERIES**

**CAPACITANCE RANGE – X7R DIELECTRIC 1210 SIZES**

*Table 4-J*

Size	1210							
	10	16	25	50	100	250	500	1000
VDC (V)								
6,800pF (682)	C	C	C	C	C	C	D	G
8,200pF (822)	C	C	C	C	C	C	D	G
0.010μF (103)	C	C	C	C	C	C	D	G
0.012μF (123)	C	C	C	C	C	C	D	
0.015μF (153)	C	C	C	C	C	C	D	
0.018μF (183)	C	C	C	C	C	C	D	
0.022μF (223)	C	C	C	C	C	C	D	
0.027μF (273)	C	C	C	C	C	C		
0.033μF (333)	C	C	C	C	C	C		
0.039μF (393)	C	C	C	C	C	C		
0.047μF (473)	C	C	C	C	C	D		
0.056μF (563)	C	C	C	C	C			
0.068μF (683)	C	C	C	C	C			
0.082μF (823)	C	C	C	C	C			
0.10μF (104)	C	C	C	C	C			
0.12μF (124)	C	C	C	C				
0.15μF (154)	C	C	C	C				
0.18μF (184)	C	C	C	C				
0.22μF (224)	C	C	C	C				
0.27μF (274)	C	C	C	C				
0.33μF (334)	C	C	C	D				
0.39μF (394)	C	C	C	D				
0.47μF (474)	C	C	C	D				
0.56μF (564)	D	D	D	D				
0.68μF (684)	D	D	D	D				
0.82μF (824)	D	D	D	D				
1.0μF (105)	D	D	D	D				
1.5μF (155)		K						
2.2μF (225)		K						

**MULTILAYER CERAMIC CHIP CAPACITORS MT SERIES**

**High Temperature Exposure – Requirements–X7R**

*Table 5*

Rated vol.	DF ≤	Exception of DF ≤	
≥50V	≤ 3%	≤ 6%	0201(50V); 0603≥0.047μF; 0805≥0.18μF; 1206≥0.47μF;
		≤ 10%	1210≥4.7μF;
		≤ 20%	0402≥0.1μF; 0603≥1μF; 0805≥1μF; 1206≥2.2μF;
35V	≤ 5%	≤20%	0603≥1μF; 0805≥2.2μF; 1210≥10μF;
25V	≤ 5%	≤10%	0201≥0.01μF; 0805≥1μF; 1210≥10μF
		≤15%	0603≥0.33μF; 1206≥4.7μF; 0402≥0.10μF; 0603≥0.47μF; 0805≥2.2μF; 1206≥6.8μF; 1210≥22μF;
16V	≤5%	≤10%	0603≥0.15μF;0805≥0.68μF;1206≥2.2μF;1210≥4.7μF
		≤15%	0201≥0.01μF;0402≥0.033μF; 0603≥0.68μF;0805≥2.2μF 1206≥4.7μF; 1210≥22μF;
10V	≤ 7.5%	≤15%	0201≥0.012μF;0402≥0.33μF; 0603≥0.33μF;0805≥2.2μF 1206≥2.2μF; 1210≥22μF
		≤20%	0201≥0.1μF ;0402≥1μF;
6.3V	≤ 15%	≤30%	0201≥0.1μF;0402≥1μF; 0603≥10μF;0805≥4.7μF; 1206≥47μF;1210≥100μF;
4V	≤20%	---	---

IR.: ≥10GΩ or RxC≥500Ω-F whichever is smaller

**High Temperature Exposure – Requirements –Class II-X7R**

*Table 6*

Rated voltage	Insulation Resistance
≥100V: X7R	1GΩ or RxC≥10Ω-F whichever is smaller
50V:0603≥1μF;0805≥1μF; 1206≥4.7μF;1210≥4.7μF	
35V:0805≥2.2μF;1210≥10μF	
25V:0402≥1μF;0603≥2.2μF;0805≥2.2μF; 1206≥10μF;1210≥10μF	
16V: 0201≥0.1μF;0402≥0.22μF; 0603≥1μF;0805≥2.2μF; 1206≥10μF;1210≥47μF	
10V:0201≥47nF;0402≥0.47μF; 0603≥0.47μF;0805≥2.2μF; 1206≥4.7μF;1210≥47μF	

**MULTILAYER CERAMIC CHIP CAPACITORS MT SERIES**
**Temperature Cycling-Requirements –X7R**
**Table 7**

Rated vol.	DF ≤	Exception of DF ≤	
≥50V	≤ 3%	≤ 6%	0201(50V); 0603≥0.047μF; 0805≥0.18μF; 1206≥0.47μF;
		≤ 10%	1210≥4.7μF;
		≤ 20%	0402≥0.1μF;0603≥1μF; 0805≥1μF;1206≥2.2μF; 1210≥10μF;
35V	≤ 5%	≤20%	0603≥1μF; 0805≥2.2μF; 1210≥10μF;
25V	≤ 5%	≤10%	0201≥0.01μF; 0805≥1μF; 1210≥10μF
		≤14%	0603≥0.33μF;1206≥4.7μF
		≤15%	0402≥0.10μF;0603≥0.47μF;0805≥2.2μF;1206≥6.8μF; 1210≥22μF;
16V	≤5%	≤10%	0603≥0.15μF;0805≥0.68μF;1206≥2.2μF;1210≥4.7μF
		≤15%	0201≥0.01μF;0402≥0.033μF; 0603≥0.68μF;0805≥2.2μF 1206≥4.7μF; 1210≥22μF;
10V	≤ 7.5%	≤15%	0201≥0.012μF;0402≥0.33μF; 0603≥0.33μF;0805≥2.2μF 1206≥2.2μF; 1210≥22μF
		≤20%	0201≥0.1μF ;0402≥1μF;
6.3V	≤ 15%	≤30%	0201≥0.1μF;0402≥1μF;0603 ≥10μF; 0805≥4.7μF;1206≥47μF;1210≥100μF;
4V	≤20%	---	---

IR.: ≥10GΩ or RxC≥500Ω-F whichever is smaller

**Temperature Cycling– Requirements –Class II-X7R**
**Table 8**

Rated voltage	Insulation Resistance
≥100V: X7R	1GΩ or RxC≥10Ω-F whichever is smaller
50V:0603≥1μF;0805≥1μF; 1206≥4.7μF;1210≥4.7μF	
35V:0805≥2.2μF;1210≥10μF	
25V:0402≥1μF;0603≥2.2μF;0805≥2.2μF; 1206≥10μF;1210≥10μF	
16V: 0201≥0.1uF;0402≥0.22μF; 0603≥1μF;0805≥2.2μF; 1206≥10μF;1210≥47μF	
10V:0201≥47nF;0402≥0.47μF; 0603≥0.47μF;0805≥2.2μF; 1206≥4.7μF;1210≥47μF	
6.3V; 4V;	

**MULTILAYER CERAMIC CHIP CAPACITORS MT SERIES**

**Moisture Resistance – Requirements –X7R**

*Table 9*

Rated vol.	DF ≤	Exception of DF ≤	
≥50V	≤ 3%	≤ 6%	0201(50V); 0603≥0.047μF; 0805≥0.18μF; 1206≥0.47μF;
		≤ 10%	1210≥4.7μF;
		≤ 20%	0402≥0.1μF;0603≥1μF; 0805≥1μF;1206≥2.2μF; 1210≥10μF; TT series
35V	≤ 5%	≤20%	0603≥1μF; 0805≥2.2μF; 1210≥10μF;
25V	≤ 5%	≤10%	0201≥0.01μF; 0805≥1μF; 1210≥10μF
		≤14%	0603≥0.33μF;1206≥4.7μF
		≤15%	0402≥0.10μF;0603≥0.47μF;0 805≥2.2μF;1206≥6.8μF; 1210≥22μF; TT series
16V	≤5%	≤10%	0603≥0.15μF;0805≥0.68μF;1206≥2.2μF;1210≥4.7μF
		≤15%	0201≥0.01μF;0402≥0.033μF; 0603≥0.68μF;0805≥2.2μF 1206≥4.7μF; 1210≥22μF; TT series
10V	≤ 7.5%	≤15%	0201≥0.012μF;0402≥0.33μF; 0603≥0.33μF;0805≥2.2μF 1206≥2.2μF; 1210≥22μF
		≤20%	0201≥0.1μF ;0402≥1μF; TT series
6.3V	≤ 15%	≤30%	0201≥0.1μF;0402≥1μF;0603 ≥10μF; 0805≥4.7μF;1206≥47μF;1210≥100μF;
4V	≤20%	---	---

IR.: ≥10GΩ or RxC≥500Ω-F whichever is smaller

**Moisture Resistance– Requirements –Class II-X7R**

*Table 10*

Rated voltage	Insulation Resistance
≥100V: X7R	1GΩ or RxC≥10Ω-F whichever is smaller
50V:0603≥1μF;0805≥1μF; 1206≥4.7μF;1210≥4.7μF	
35V:0805≥2.2μF;1210≥10μF	
25V:0402≥1μF;0603≥2.2μF;0805≥2.2μF; 1206≥10μF;1210≥10μF	
16V: 0201≥0.1uF;0402≥0.22μF; 0603≥1μF;0805≥2.2μF; 1206≥10μF;1210≥47μF	
10V:0201≥47nF;0402≥0.47μF; 0603≥0.47μF;0805≥2.2μF; 1206≥4.7μF;1210≥47μF	
6.3V; 4V;	

**MULTILAYER CERAMIC CHIP CAPACITORS MT SERIES**
**Biased Humidity- Requirements –X7R**
**Table 11**

Rated vol.	DF ≤	Exception of DF ≤	
≥50V	≤ 3%	≤ 6%	0201(50V); 0603≥0.047μF; 0805≥0.18μF; 1206≥0.47μF;
		≤ 10%	1210≥4.7μF;
		≤ 20%	0402≥0.1μF;0603≥1μF; 0805≥1μF;1206≥2.2μF; 1210≥10μF;
35V	≤ 5%	≤20%	0603≥1μF; 0805≥2.2μF; 1210≥10μF;
25V	≤ 5%	≤10%	0201≥0.01μF; 0805≥1μF; 1210≥10μF
		≤14%	0603≥0.33μF;1206≥4.7μF
		≤15%	0402≥0.10μF;0603≥0.47μF;0805≥2.2μF;1206≥6.8μF; 1210≥22μF;
16V	≤5%	≤10%	0603≥0.15μF;0805≥0.68μF;1206≥2.2μF;1210≥4.7μF
		≤15%	0201≥0.01μF;0402≥0.033μF; 0603≥0.68μF;0805≥2.2μF 1206≥4.7μF; 1210≥22μF;
10V	≤ 7.5%	≤15%	0201≥0.012μF;0402≥0.33μF; 0603≥0.33μF;0805≥2.2μF 1206≥2.2μF; 1210≥22μF
		≤20%	0201≥0.1μF ;0402≥1μF;
6.3V	≤ 15%	≤30%	0201≥0.1μF;0402≥1μF;0603 ≥10μF; 0805≥4.7μF;1206≥47μF;1210≥100μF;
4V	≤20%	---	---

IR.: ≥10GΩ or RxC≥50Ω-F whichever is smaller

**Biased Humidity- Requirements –Class II-X7R for rated voltage test**
**Table 12**

Rated voltage	Insulation Resistance
≥100V: X7R	500MΩ or R x C ≥5 Ω-F whichever is smaller.
50V:0603≥1μF;0805≥1μF; 1206≥4.7μF;1210≥4.7μF	
35V:0805≥2.2μF;1210≥10μF	
25V:0402≥1μF;0603≥2.2μF;0805≥2.2μF; 1206≥10μF;1210≥10μF	
16V: 0201≥0.1μF;0402≥0.22μF; 0603≥1μF;0805≥2.2μF; 1206≥10μF;1210≥47μF	
10V:0201≥47nF;0402≥0.47μF; 0603≥0.47μF;0805≥2.2μF; 1206≥4.7μF;1210≥47μF	
6.3V; 4V;	

**MULTILAYER CERAMIC CHIP CAPACITORS MT SERIES**

**Biased Humidity-- Requirements –Class II-X7R for 1.3V~1.5V**

**Table 13**

Rated voltage	Insulation Resistance
≥100V: X7R	1GΩ or R x C ≥10 Ω-F whichever is smaller.
50V:0603≥1μF;0805≥1μF; 1206≥4.7μF;1210≥4.7μF	
35V:0805≥2.2μF;1210≥10μF	
25V:0402≥1μF;0603≥2.2μF;0805≥2.2μF; 1206≥10μF;1210≥10μF	
16V: 0201≥0.1μF;0402≥0.22μF; 0603≥1μF;0805≥2.2μF; 1206≥10μF;1210≥47μF	
10V:0201≥47nF;0402≥0.47μF; 0603≥0.47μF;0805≥2.2μF; 1206≥4.7μF;1210≥47μF	
6.3V; 4V;	

**Operational Life-Requirements –X7R**

**Table 14**

Rated vol.	DF ≤	Exception of DF ≤	
		DF ≤	Exception of DF ≤
≥50V	≤ 3%	≤ 6%	0201(50V); 0603≥0.047μF; 0805≥0.18μF; 1206≥0.47μF;
		≤ 10%	1210≥4.7μF;
		≤ 20%	0402≥0.1μF;0603≥1μF; 0805≥1μF;1206≥2.2μF; 1210≥10μF;
35V	≤ 5%	≤20%	0603≥1μF; 0805≥2.2μF; 1210≥10μF;
25V	≤ 5%	≤10%	0201≥0.01μF; 0805≥1μF; 1210≥10μF
		≤14%	0603≥0.33μF;1206≥4.7μF
		≤15%	0402≥0.10μF;0603≥0.47μF;0805≥2.2μF;1206≥6.8μF; 1210≥22μF;
16V	≤5%	≤10%	0603≥0.15μF;0805≥0.68μF;1206≥2.2μF;1210≥4.7μF
		≤15%	0201≥0.01μF;0402≥0.033μF; 0603≥0.68μF;0805≥2.2μF 1206≥4.7μF; 1210≥22μF;
10V	≤ 7.5%	≤15%	0201≥0.012μF;0402≥0.33μF; 0603≥0.33μF;0805≥2.2μF 1206≥2.2μF; 1210≥22μF
		≤20%	0201≥0.1μF ;0402≥1μF;
6.3V	≤ 15%	≤30%	0201≥0.1μF;0402≥1μF;0603 ≥10μF; 0805≥4.7μF;1206≥47μF;1210≥100μF;
4V	≤20%	---	---

IR.: ≥10GΩ or RxC≥50Ω-F whichever is smaller



**MULTILAYER CERAMIC CHIP CAPACITORS MT SERIES**
**Operational Life-Requirements –X7R-Class II**
*Table 15*

Rated voltage	Insulation Resistance
≥100V: X7R	1GΩ or $RxC \geq 100\Omega\cdot F$ whichever is smaller
50V:0603≥1μF;0805≥1μF; 1206≥4.7μF;1210≥4.7μF	
35V:0805≥2.2μF;1210≥10μF	
25V:0402≥1μF;0603≥2.2μF;0805≥2.2μF; 1206≥10μF;1210≥10μF	
16V: 0201≥0.1μF;0402≥0.22μF; 0603≥1μF;0805≥2.2μF; 1206≥10μF;1210≥47μF	
10V:0201≥47nF;0402≥0.47μF; 0603≥0.47μF;0805≥2.2μF; 1206≥4.7μF;1210≥47μF	
6.3V; 4V;	

**Moisture Resistance II, Mechanical Shock, Vibration, Resistance to Soldering Heat , Thermal Shock, Electrical Characterization-Requirements –X7R**
*Table 16*

Rated vol.	DF ≤	Exception of DF ≤	
		≤ 3%	
≥50V	≤2.5%	≤ 3%	0201(50V);0603≥0.047μF; 0805≥0.18μF; 1206≥0.47μF
		≤ 5%	1210≥4.7μF;
		≤ 10%	0402≥0.1μF;0603≥1μF; 0805≥1μF;1206≥2.2μF; 1210≥10μF;
35V	≤ 3.5%	≤10%	0603≥1μF; 0805≥2.2μF; 1210≥10μF;
25V	≤ 3.5%	≤5%	0201≥0.01μF; 0805≥1μF; 1210≥10μF
		≤7%	0603≥0.33μF;1206≥4.7μF
		≤10%	0402≥0.10μF;0603≥0.47μF;0805≥2.2μF;1206≥6.8μF; 1210≥22μF;
16V	≤3.5%	≤5%	0603≥0.15μF;0805≥0.68μF;1206≥2.2μF;1210≥4.7μF
		≤10%	0201≥0.01μF;0402≥0.033μF; 0603≥0.68μF;0805≥2.2μF 1206≥4.7μF; 1210≥22μF;
10V	≤ 5%	≤10%	0201≥0.012μF;0402≥0.33μF; 0603≥0.33μF;0805≥2.2μF 1206≥2.2μF; 1210≥22μF
		≤15%	0201≥0.1μF ;0402≥1μF;
6.3V	≤ 10%	≤15%	0201≥0.1μF;0402≥1μF;0603 ≥10μF; 0805≥4.7μF;1206≥47μF;1210≥100μF;
		≤20%	0402≥2.2μF;
4V	≤15%	---	---

 IR.: ≥10GΩ or  $RxC \geq 500\Omega\cdot F$  whichever is smaller

**MULTILAYER CERAMIC CHIP CAPACITORS MT SERIES**
**ESD-Requirements –X7R**
**Table 17**

Rated vol.	DF ≤	Exception of DF ≤	
≥50V	≤2.5%	≤ 3%	0201(50V);0603≥0.047μF; 0805≥0.18μF; 1206≥0.47μF
		≤ 5%	1210≥4.7μF;
		≤ 10%	0402≥0.1μF;0603≥1μF; 0805≥1μF;1206≥2.2μF; 1210≥10μF;
35V	≤ 3.5%	≤10%	0603≥1μF; 0805≥2.2μF; 1210≥10μF;
25V	≤ 3.5%	≤5%	0201≥0.01μF; 0805≥1μF; 1210≥10μF
		≤7%	0603≥0.33μF;1206≥4.7μF
		≤10%	0402≥0.10μF;0603≥0.47μF;0805≥2.2μF;1206≥6.8μF; 1210≥22μF;
16V	≤3.5%	≤5%	0603≥0.15μF;0805≥0.68μF;1206≥2.2μF;1210≥4.7μF
		≤10%	0201≥0.01μF;0402≥0.033μF; 0603≥0.68μF;0805≥2.2μF 1206≥4.7μF; 1210≥22μF;
10V	≤ 5%	≤10%	0201≥0.012μF;0402≥0.33μF; 0603≥0.33μF;0805≥2.2μF 1206≥2.2μF; 1210≥22μF
		≤15%	0201≥0.1μF ;0402≥1μF;
6.3V	≤ 10%	≤15%	0201≥0.1μF;0402≥1μF;0603 ≥10μF; 0805≥4.7μF;1206≥47μF;1210≥100μF;
		≤20%	0402≥2.2μF;
4V	≤15%	---	---

IR.: ≥10GΩ or RxC≥50Ω-F whichever is smaller

**Mechanical Shock, Vibration – Requirements –X7R-Class II**
**Table 18**

Rated voltage	Insulation Resistance
≥100V: X7R	10GΩ or R x C ≥100 Ω-F whichever is smaller.
50V:0603≥1μF;0805≥1μF; 1206≥4.7μF;1210≥4.7μF	
35V:0805≥2.2μF;1210≥10μF	
25V:0402≥1μF;0603≥2.2μF;0805≥2.2μF; 1206≥10μF;1210≥10μF	
16V: 0201≥0.1uF;0402≥0.22μF; 0603≥1μF;0805≥2.2μF; 1206≥10μF;1210≥47μF	
10V:0201≥47nF;0402≥0.47μF; 0603≥0.47μF;0805≥2.2μF; 1206≥4.7μF;1210≥47μF	
6.3V; 4V;	

**MULTILAYER CERAMIC CHIP CAPACITORS MT SERIES**

**Terminal Strength-Requirements –X7R**

*Table 19*

Rated vol.	DF ≤	Exception of DF ≤	
≥50V	≤2.5%	≤ 3%	0201(50V);0603≥0.047μF; 0805≥0.18μF; 1206≥0.47μF
		≤ 5%	1210≥4.7μF;
		≤ 10%	0402≥0.1μF;0603≥1μF; 0805≥1μF;1206≥2.2μF; 1210≥10μF;
35V	≤ 3.5%	≤10%	0603≥1μF; 0805≥2.2μF; 1210≥10μF;
25V	≤ 3.5%	≤5%	0201≥0.01μF; 0805≥1μF; 1210≥10μF
16V	≤3.5%	≤5%	0201≥0.01μF;0402≥0.033μF;0603 ≥0.15μF;0805≥0.68μF; 1206≥2.2μF;1210≥4.7μF
		≤10%	0201≥0.1uF; 0402≥ 0.22uF; 0603≥0.68μF;0805≥2.2μF; 1206≥4.7μF; 1210≥22μF;
10V	≤ 5%	≤10%	0201≥0.012μF;0402≥0.33μF; 0603≥0.33μF;0805≥2.2μF 1206≥2.2μF; 1210≥22μF
		≤15%	0201≥0.1μF ;0402≥1μF;
6.3V	≤ 10%	≤15%	0201≥0.1μF;0402≥1μF;0603 ≥10μF; 0805≥4.7μF;1206≥47μF;1210≥100μF;
		≤20%	0402≥2.2μF;
4V	≤15%	---	---

**Moisture Resistance II, Resistance to Soldering Heat- Requirements –X7R-Class II**

*Table 20*

Rated voltage	Insulation Resistance
≥100V: X7R	10GΩ or R x C ≥10 Ω-F whichever is smaller.
50V:0603≥1μF;0805≥1μF; 1206≥4.7μF;1210≥4.7μF	
35V:0805≥2.2μF;1210≥10μF	
25V:0402≥1μF;0603≥2.2μF;0805≥2.2μF; 1206≥10μF;1210≥10μF	
16V: 0201≥0.1uF;0402≥0.22μF; 0603≥1μF;0805≥2.2μF; 1206≥10μF;1210≥47μF	
10V:0201≥47nF;0402≥0.47μF; 0603≥0.47μF;0805≥2.2μF; 1206≥4.7μF;1210≥47μF	
6.3V; 4V;	

**MULTILAYER CERAMIC CHIP CAPACITORS MT SERIES**

**Thermal Shock –Requirements –X7R-Class II**

*Table 21*

Rated voltage	Insulation Resistance
≥100V: X7R	1GΩ or R x C ≥10 Ω-F whichever is smaller.
50V:0603≥1μF;0805≥1μF; 1206≥4.7μF;1210≥4.7μF	
35V:0805≥2.2μF;1210≥10μF	
25V:0402≥1μF;0603≥2.2μF;0805≥2.2μF; 1206≥10μF;1210≥10μF	
16V: 0201≥0.1uF;0402≥0.22μF; 0603≥1μF;0805≥2.2μF; 1206≥10μF;1210≥47μF	
10V:0201≥47nF;0402≥0.47μF; 0603≥0.47μF;0805≥2.2μF; 1206≥4.7μF;1210≥47μF	
6.3V; 4V;	

**ESD –Requirements –X7R-Class II**

*Table 22*

Rated voltage	Insulation Resistance
≥100V: X7R	1GΩ or R x C ≥100 Ω-F whichever is smaller.
50V:0603≥1μF;0805≥1μF; 1206≥4.7μF;1210≥4.7μF	
35V:0805≥2.2μF;1210≥10μF	
25V:0402≥1μF;0603≥2.2μF;0805≥2.2μF; 1206≥10μF;1210≥10μF	
16V: 0201≥0.1uF;0402≥0.22μF; 0603≥1μF;0805≥2.2μF; 1206≥10μF;1210≥47μF	
10V:0201≥47nF;0402≥0.47μF; 0603≥0.47μF;0805≥2.2μF; 1206≥4.7μF;1210≥47μF	
6.3V; 4V;	

**Electrical Characterization –Requirements –X7R-Class II**

*Table 23*

Rated voltage	Insulation Resistance
≥100V: X7R	10GΩ or R x C ≥100 Ω-F whichever is smaller.
50V:0603≥1μF;0805≥1μF; 1206≥4.7μF;1210≥4.7μF	
35V:0805≥2.2μF;1210≥10μF	
25V:0402≥1μF;0603≥2.2μF;0805≥2.2μF; 1206≥10μF;1210≥10μF	
16V: 0201≥0.1uF;0402≥0.22μF; 0603≥1μF;0805≥2.2μF; 1206≥10μF;1210≥47μF	
10V:0201≥47nF;0402≥0.47μF; 0603≥0.47μF;0805≥2.2μF; 1206≥4.7μF;1210≥47μF	
6.3V; 4V; TT series	

**MULTILAYER CERAMIC CHIP CAPACITORS MT SERIES**

**RELIABILITY TEST CONDITIONS AND REQUIREMENTS**

Item	AEC-Q200 Test Condition	Requirements
<b>Pre-and Post-Stress Electrical Test</b>	-	
<b>High Temperature Exposure (Storage) MIL-STD-202 Method 108</b>	* Test temp.: $150 \pm 3^{\circ} \text{C}$ * Unpowered. * Test time: 1000+24/-0 hrs. * Measurement to be made after keeping at room temp. for $24 \pm 2$ hrs.	*No remarkable damage. *Cap change: NPO: within $\pm 2.5\%$ or $\pm 0.25\text{pF}$ whichever is larger. X7R: within $\pm 10.00\%$ . * Q/D.F. value: NPO: $\text{Cap} \geq 30\text{pF}$ , $Q \geq 1000$ ; $\text{Cap} < 30\text{pF}$ , $Q \geq 400+20\text{C}$ . X7R, See <Table 5> Class II (X7R) , See <Table 6>
<b>Temperature : Cycling JESD22 Method JA-104</b>	*Conduct 1000 cycles according to the temperatures and time. Step 1: $-55^{\circ} \text{C} +0/-3^{\circ} \text{C}$ @ $5 \pm 1$ min. Step 2: $+125^{\circ} \text{C} +3/-0^{\circ} \text{C}$ @ $5 \pm 1$ min. Before initial measurement (X7R only): Perform $150+0/-10^{\circ} \text{C}$ for 1 hr and then set for $24 \pm 2$ hrs at room temp. *Measurement to be made after keeping at room temp. for $24 \pm 2$ hrs.	* No remarkable damage. *Cap change: NPO: within $\pm 2.5\%$ or $\pm 0.25\text{pF}$ whichever is larger. X7R: within $\pm 10.00\%$ . *Q/D.F. value: NPO: $\text{Cap} \geq 30\text{pF}$ , $Q \geq 1000$ ; $\text{Cap} < 30\text{pF}$ , $Q \geq 400+20\text{C}$ X7R, See <Table 7> Class II (X7R) , See <Table 8>

**MULTILAYER CERAMIC CHIP CAPACITORS MT SERIES**

**RELIABILITY TEST CONDITIONS AND REQUIREMENTS**

Item	AEC-Q200 Test Condition	Requirements
<b>Destructive Physical Analysis EIA-469</b>	Per EIA-469	No defects or abnormalities
<b>Moisture Resistance MIL-STD-202 Method 106</b>	Test temp.: 25~65° C Humidity: 80~100% RH Test time: 10 cycles, t=24hrs/cycle. Measurement to be made after keeping at room temp. for 24±2 hrs.	* No remarkable damage. * Cap change: NPO: within ±3.0% or ±0.30pF whichever is larger. X7R: within ±12.5%. *Q/D.F. value: NPO: More than 30pF Q≥350 ; 10pF≤C≤30pF, Q≥275+2.5C Less than 10pF Q≥200+10. X7R, See <Table 9> Class II (X7R) , See <Table 10>
<b>Biased Humidity MIL-STD-202 Method 103</b>	Test temp.: 85±3° C Humidity: 85%RH Test time: 1000+24/-0 hrs. To apply voltage: rated voltage and 1.3~1.5Vdc. (add 100k ohm resistor) Before initial measurement (Class II only) : To apply test voltage for 1hr at test temp. and then set for 24±2 hrs at room temp. Measurement to be made after keeping at room temp. for 24±2hrs.	* No remarkable damage. * Cap change: NPO: within ±3.0% or ±0.30pF whichever is larger. X7R: within ±12.5%. *Q/D.F. value: NPO: C≥30pF Q≥200 ; C≤30pF, Q≥100+10/3C X7R, See <Table 11> Class II (X7R) , See <Table 12> <Table 13>

**MULTILAYER CERAMIC CHIP CAPACITORS MT SERIES**

**RELIABILITY TEST CONDITIONS AND REQUIREMENTS**

Item	AEC-Q200 Test Condition	Requirements
<b>Operational Life</b> <b>MIL-STD-202</b> <b>Method 108</b>	Test temp.: $125 \pm 3^\circ \text{C}$  To apply voltage: full rated voltage.  * Test time: 1000+24/-0 hrs. Before initial measurement (X7R only): Apply rated voltage for 1 hr at $125^\circ\text{C}$ . Remove and let set for $24 \pm 2$ hrs at room temp.  Measurement to be made after keeping at room temp. for $24 \pm 2$ hrs.	* No remarkable damage.  * Cap change: NPO: within $\pm 3.0\%$ or $\pm 0.30\text{pF}$ whichever is larger. X7R: within $\pm 12.5\%$ .  *Q/D.F. value: NPO: More than 30pF $Q \geq 350$ ; 10pF $\leq C \leq 30\text{pF}$ , $Q \geq 275 + 2.5C$ Less than 10pF $Q \geq 200 + 10$ . X7R, See <Table 14> Class II (X7R) , See <Table 15>
<b>External Visual</b> <b>MIL-STD-883</b> <b>Method 2009</b>	Visual inspection	No remarkable defect.
<b>Physical</b> <b>Dimension JESD22</b> <b>Method JB-100</b>	Using by calipers	Within the specified dimensions
<b>Moisture</b> <b>Resistance II</b> <b>MIL-STD-202</b> <b>Method 106</b>	* Temperature: $25 \pm 5^\circ \text{C}$  * Time: 3+0.5/-0 min.  *Solvent: Iso - propyl alcohol.	* No remarkable damage.  * Cap change: within the specified tolerance.  *Q/D.F. value: NPO: Cap $\geq 30\text{pF}$ , $Q \geq 1000$ ; Cap $< 30\text{pF}$ , $Q \geq 400 + 20C$ X7R, See <Table 16> Class II (X7R) , See <Table 20>

**MULTILAYER CERAMIC CHIP CAPACITORS MT SERIES**

**RELIABILITY TEST CONDITIONS AND REQUIREMENTS**

Item	AEC-Q200 Test Condition	Requirements
<b>Mechanical Shock</b> <b>IL-STD-202</b> <b>Method 213</b>	Peak value: 1500g's. Wave: 1/2 sine. Velocity: 15.4 ft/sec Three shocks in each direction should be applied along 3 mutually perpendicular axes of the test specimen (18 shocks)	* No remarkable damage. * Cap change: within the specified tolerance. *Q/D.F. value: NPO: Cap $\geq$ 30pF, Q $\geq$ 1000 ; Cap $<$ 30pF, Q $\geq$ 400+20C X7R, See <Table 16> Class II (X7R) , See <Table 18>
<b>Vibration MIL-STD-202 Method 204</b>	Vibration frequency:10~2000Hz/min. (5g's for 20 min) Total amplitude: 1.5mm 12 cycles each of 3 orientations (36 times)	* No remarkable damage. * Cap change: within the specified tolerance. *Q/D.F. value: NPO: Cap $\geq$ 30pF, Q $\geq$ 1000 ; Cap $<$ 30pF, Q $\geq$ 400+20C X7R, See <Table 16> Class II (X7R) , See <Table 18>
<b>Resistance to Soldering Heat</b> <b>MIL-STD-202</b> <b>Method 210</b>	*Solder temperature: 270 $\pm$ 5 $^{\circ}$ C *Dipping time: 10 $\pm$ 1 sec *Before initial measurement (X7R only): Perform 150+0/-10 $^{\circ}$ C for 1 hr and then set for 24 $\pm$ 2 hrs at room temp. * Measurement to be made after keeping X7R: at room temp. for 24 $\pm$ 2 hrs.	* No remarkable damage. * Cap change: NPO: within $\pm$ 2.5% or 0.25pF whichever is larger X7R: within $\pm$ 7.5% *Q/D.F. value: NPO: Cap $\geq$ 30pF, Q $\geq$ 1000 ; Cap $<$ 30pF, Q $\geq$ 400+20C X7R, See <Table 16> Class II (X7R) , See <Table 20>



**MULTILAYER CERAMIC CHIP CAPACITORS MT SERIES**

**RELIABILITY TEST CONDITIONS AND REQUIREMENTS**

Item	Test Condition	Requirements
<b>Thermal Shock II-STD-202 Method 107</b>	<p>*Conduct 300 cycles according to the temperatures and time. transfer time: 20 sec.</p> <p>Step 1: -55° C +0/-3° C @ 15±3 min.</p> <p>Step 2: +125° C +3/-0° C @ 15±3 min.</p> <p>*Max.transfer time:20 sec</p> <p>*Before initial measurement (X7R only): Perform 150+0/-10° C for 1 hr and then set for 24±2 hrs at room temp.</p> <p>*Measurement to be made after keeping at room temp. for 24±2 hrs</p>	<p>* No remarkable damage.</p> <p>* Cap change: NPO: within ±2.5% or 0.25pF whichever is larger X7R: within ±10.0%</p> <p>*Q/D.F. value: NPO: Cap≥30pF, Q≥1000 ; Cap&lt;30pF, Q≥400+20C X7R, See &lt;Table 16&gt; Class II (X7R) , See &lt;Table 21&gt;</p>
<b>ESD AEC-Q200-002</b>	<p>Per AEC-Q200-002</p>	<p>* No remarkable damage.</p> <p>* Cap change: within the specified tolerance.</p> <p>*Q/D.F. value: NPO: Cap≥30pF, Q≥1000 ; Cap&lt;30pF, Q≥400+20C X7R, See &lt;Table 17&gt; Class II (X7R) , See &lt;Table 22&gt;</p>
<b>Solderability J-STD-002 JESD22-B102E</b>	<p>*Condition A Un-mounted chips 4hrs / 155° C</p> <p>*dry then completely immersed for 5±0.5 sec in solder bath at 245±5° C.</p> <p>*Condition B Un-mounted chips steam 8 hrs then completely immersed for 10±1sec in solder bath at 220+5/-0° C.</p> <p>*Condition C Un-mounted chips steam 8 hrs then completely immersed for 10±1 sec. in solder bath at 260+0/-5° C.</p>	<p>All terminations shall exhibit a continuous solder coating free from defects from a minimum of 95% of the critical surface area of any individual termination.</p>

**MULTILAYER CERAMIC CHIP CAPACITORS MT SERIES**

**RELIABILITY TEST CONDITIONS AND REQUIREMENTS**

Item	Test Condition	Requirements
<p><b>Electrical Characterization</b></p>	<p>*Capacitance</p> <p>*Q/ D.F. (Dissipation Factor) Cap≤1000pF 1.0±0.2Vrms, 1MHz±10%</p> <p>Cap&gt;1000pF 1.0±0.2Vrms, 1KHz±10%</p> <p>*Insulation Resistance To apply rated voltage(500V max.) for max. 120 sec.</p> <p>*Dielectric Strength To apply voltage: ≤100                    ≥2.5 times VDC 200V~300V            ≥2 times VDC 400V~450V            ≥1.2 times VDC 500V~999V      ≥1.5 times VDC 1000V~3000V ≥1.2 times VDC , duration 1~5 sec, charge and discharge current less than 50mA.</p> <p>*Temperature Coefficient (with no electrical load) Operation temperature: -55~125° C at 25° C</p>	<p>* Cap change: within the specified tolerance.</p> <p>*Q/D.F. value: NPO: Cap≥30pF, Q≥1000 ; Cap&lt;30pF, Q≥400+20C X7R, See &lt;Table 16&gt; Class II (X7R) , See &lt;Table 23&gt;</p> <p>*Dielectric strength No evidence of damage or flash over during test.</p> <p>*Temperature Coefficient Capacitance Change: NPO: Within ±30ppm/° C X7R: Within ±15%</p>
<p><b>Board Flex AEC-Q200-005</b></p>	<p>* The middle part of substrate shall be pressurized by means of the pressurizing rod at a rate of about 1 mm per second until the deflection becomes 3mm (2mm for X7R) and then the pressure shall be maintained for 5±1 sec.</p> <p>* Measurement to be made after keeping at room temp. for 24±2 hrs.</p>	<p>* No remarkable damage.</p> <p>*Cap change: NPO: within ±5.0% or ±0.5pF whichever is larger. X7R: within ±12.5%. (This capacitance change means the change of capacitance under specified flexure of substrate from the capacitance measured before the test.)</p>

**MULTILAYER CERAMIC CHIP CAPACITORS MT SERIES**

**RELIABILITY TEST CONDITIONS AND REQUIREMENTS**

Item	Test Condition	Requirements
<b>Terminal Strength</b> <b>AEC-Q200-006</b>	* Pressurizing force: 2N (0402), 10N(0603) 18N(0805). * Test time: 60 ± 1 sec.	*No remarkable damage or removal of the terminations. * Capacitance within the specified tolerance * Q/D.F. value: NPO: Cap≥30pF, Q≥1000 ; Cap<30pF, Q≥400+20C X7R, See <Table 19>
<b>Beam Load Test</b> <b>AEC-Q200-003</b>	* Break strength test * Beam speed: 2.5 ± 0.25 mm/se	The chip endure following force * Chip length ≤2.5mm: Thickness >0.5mm (20N), ≤0.5mm (8N) * Chip length ≥3.2mm: Thickness ≥1.25mm (54.5N), <1.25mm (15N)

## MULTILAYER CERAMIC CHIP CAPACITORS MT SERIES

### RECOMMENDED PROFILE CONDITIONS

The lead-free termination MLCCs are not only to be used on SMT against lead-free solder paste, but also suitable against lead-containing solder paste.

If the optimized solder joint is requested, increasing soldering time, temperature and concentration of N2 within oven are recommended.

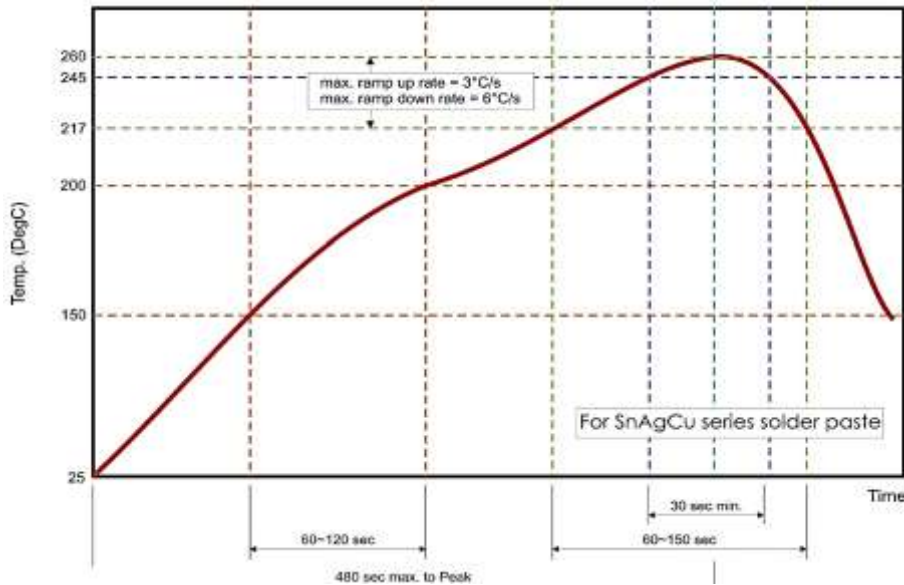

Reflow Soldering Profile For SMT Process with SnAgCu series Solder Paste

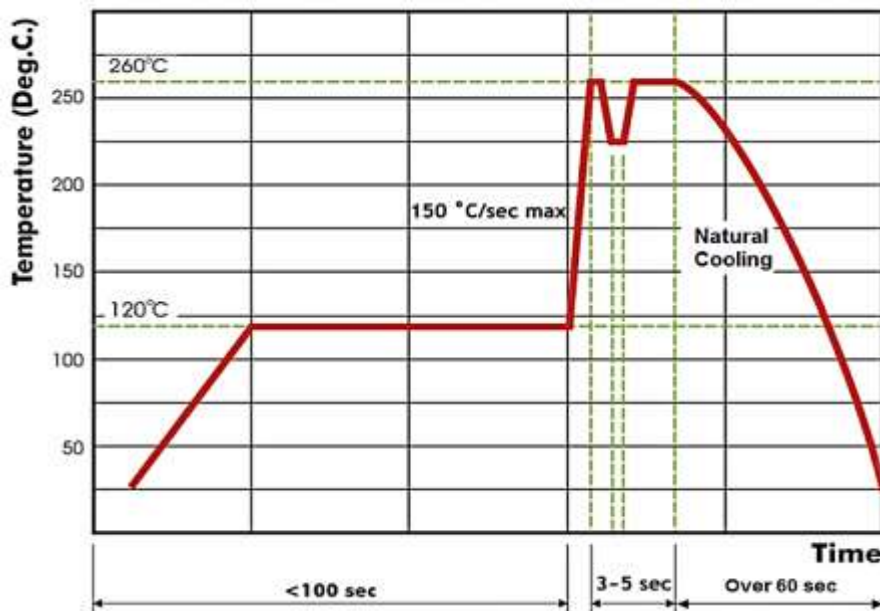

Wave Soldering Profile For SMT Process with SnAgCu series Solder Paste

**MULTILAYER CERAMIC CHIP CAPACITORS MT SERIES**

**PACKAGING STYLE AND QUANTITY**

Size	Thickness (Symbol)		Paper Tape		Plastic Tape	
			7" Reel	13" Reel	7" Reel	13" Reel
0201 (0603)	0.30±0.03	L	15,000	70,000	-	-
0402 (1005)	0.50±0.05	N	10,000	50,000		
0603 (1608)	0.80±0.07	S	4,000	15,000		
	0.80+0.15/-0.10	X	4,000	15,000		
0805 (2012)	0.60±0.10	A	4,000	15,000		
	0.85±0.10	B	4,000	15,000		
	1.25±0.10	D			3,000	10,000
	1.25±0.20	I			3,000	10,000
1206 (3216)	0.80±0.10	B	4,000	15,000		
	0.95±0.10	C			3,000	10,000
	1.15±0.15	J			3,000	10,000
	1.25±0.10	D			3,000	10,000
	1.60±0.20	G			2,000	10,000
	1.60+0.30/-0.10	P			2,000	9,000
1210 (3225)	0.95±0.10	C			3,000	10,000
	1.25±0.10	D			3,000	10,000
	1.60±0.20	G			2,000	
	2.00±0.20	K			1,000	6,000
	2.50±0.30	M			1,000	6,000

**MULTILAYER CERAMIC CHIP CAPACITORS MT SERIES**

**REEL DIMENSION (Unit: mm)**

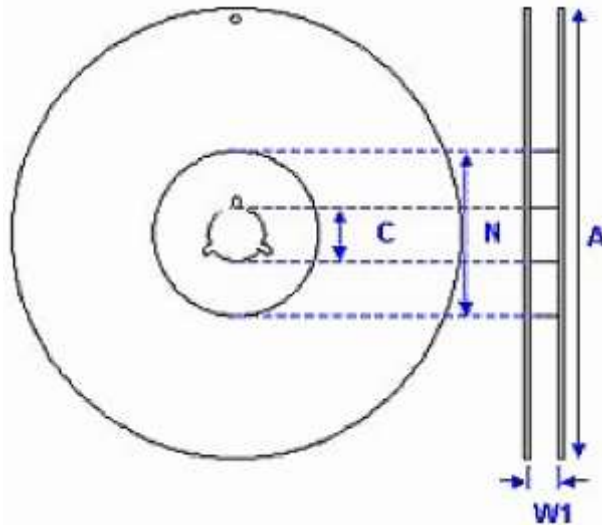

Size Code	0201, 0402, 0603, 0805, 1206, 1210		
Reel Size	7"	10"	13"
C	13.0+0.5/-0.2	13.0+0.5/-0.2	13.0+0.5/-0.2
W 1	8.4+1.5/0	8.4+1.5/-0	8.4+1.5/-0
A	178.0±0.10	250.0±1.0	330.0±1.0
N	60.0+1.0/-0	100.0±1.0	100±1.0

**TAPE DIMENSION (Unit: mm)**

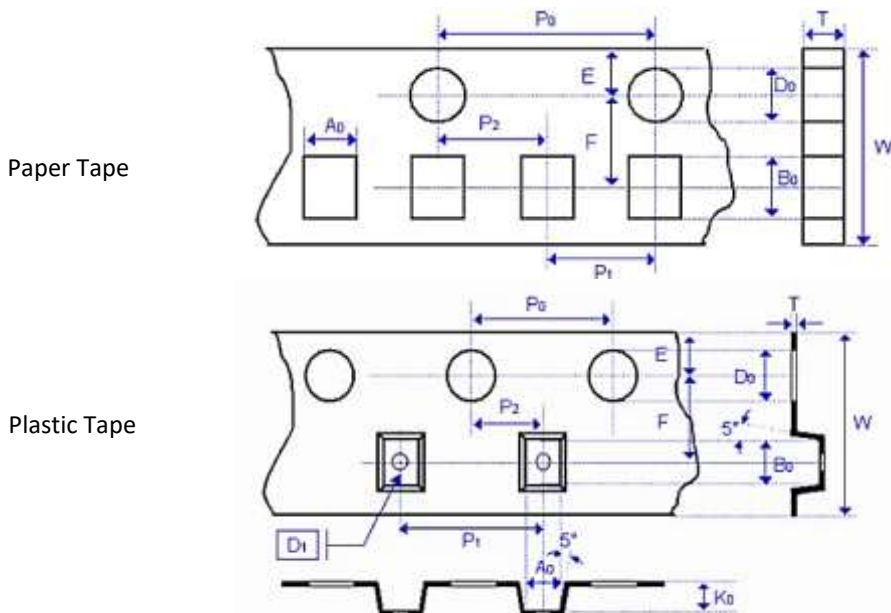

**MULTILAYER CERAMIC CHIP CAPACITORS MT SERIES**
**TAPE DIMENSION (Unit: mm)**

Size	0201	0402	0603	0805		
Thickness	L	N, E	S, H, X	A, H	B, T	D, I
A0	0.39+/-0.07	0.70+/-0.2	1.05+/-0.30	1.50+/-0.20	1.50+/-0.20	< 1.80
B0	0.69+/-0.07	1.20+/-0.2	1.80+/-0.30	2.30+/-0.20	2.30+/-0.20	< 2.70
T	≤0.50	≤0.80	≤1.20	≤1.15	≤1.30	0.23+/-0.1
W	8.00+/-0.10	8.00+/-0.10	8.00+/-0.10	8.00+/-0.10	8.00+/-0.10	8.00+/-0.20
P0	4.00+/-0.10	4.00+/-0.10	4.00+/-0.10	4.00+/-0.10	4.00+/-0.10	4.00+/-0.10
10xP0	40.00+/-0.10	40.00+/-0.10	40.00+/-0.20	40.00+/-0.20	40.00+/-0.20	40.00+/-0.20
P1	2.00+/-0.05	2.00+/-0.05	4.00+/-0.10	4.00+/-0.10	4.00+/-0.10	4.00+/-0.10
P2	2.00+/-0.05	2.00+/-0.05	2.00+/-0.05	2.00+/-0.05	2.00+/-0.05	2.00+/-0.05
D0	1.55+/-0.05	1.55+/-0.05	1.55+/-0.05	1.55+/-0.05	1.55+/-0.05	1.50+0.1/-0
D1	-	-	-	-	-	1.00+/-0.10
E	1.75+/-0.05	1.75+/-0.05	1.75+/-0.05	1.75+/-0.05	1.75+/-0.05	1.75+/-0.10
F	3.50+/-0.05	3.50+/-0.05	3.50+/-0.05	3.50+/-0.05	3.50+/-0.05	3.50+/-0.05

Size	1206			1210		
Thickness	B, T	C, J, D	G, P	T	C, D, G, K	M
A0	1.90 +/-0.50	< 2.00	< 2.30	< 3.05	< 3.05	< 3.20
B0	3.50 +/-0.50	< 3.70	< 4.00	< 3.80	< 3.80	< 3.95
T	≤1.30	0.23 +/-0.1	0.23 +/-0.1	0.23 +/-0.1	0.23 +/-0.1	0.23 +/-0.1
W	8.00 +/-0.10	8.00 +/-0.20	8.00 +/-0.20	8.00 +/-0.20	8.00 +/-0.20	8.00 +/-0.20
P0	4.00 +/-0.10	4.00 +/-0.10	4.00 +/-0.10	4.00 +/-0.10	4.00 +/-0.10	4.00 +/-0.10
10xP0	40.0 +/-0.20	40.0 +/-0.20	40.0 +/-0.20	40.0 +/-0.20	40.0 +/-0.20	40.0 +/-0.20
P1	4.00 +/-0.10	4.00 +/-0.10	4.00 +/-0.10	4.00 +/-0.10	4.00 +/-0.10	4.00 +/-0.10
P2	2.00 +/-0.05	2.00 +/-0.05	2.00 +/-0.05	2.00 +/-0.05	2.00 +/-0.05	2.00 +/-0.05
D0	1.50 +0.1/-0	1.50 +0.1/-0	1.50 +0.1/-0	1.50 +0.1/-0	1.50 +0.1/-0	1.50 +0.1/-0
D1	-	1.00 +/-0.10	1.00 +/-0.10	1.00 +/-0.10	1.00 +/-0.10	1.00 +/-0.10
E	1.75 +/-0.05	1.75 +/-0.10	1.75 +/-0.10	1.75 +/-0.10	1.75 +/-0.10	1.75 +/-0.10
F	3.50 +/-0.05	3.50 +/-0.05	3.50 +/-0.05	3.50 +/-0.05	3.50 +/-0.05	3.50 +/-0.05

## MULTILAYER CERAMIC CHIP CAPACITORS MT SERIES

### STORAGE AND HANDLING CONDITIONS

- (1) To store products at 5 to 40°C ambient temperature and 20 to 70% related humidity conditions.
- (2) The product is recommended to be used within one year after shipment. Check solder ability in case of shelf life extension is needed.

### CAUTIONS

- (1) The corrosive gas reacts on the terminal electrodes of capacitors, and results in the poor solder ability. Do not store the capacitors in the ambience of corrosive gas (e.g., hydrogen sulfide, sulfur dioxide, chlorine, ammonia gas etc.)
- (2) In corrosive atmosphere, solder ability might be degraded, and silver migration might occur to cause low reliability.
- (3) Due to the dewing by rapid humidity change, or the photochemical change of the terminal electrode by direct sun light, the solder ability and electrical performance may deteriorate. Do not store capacitors under direct sunlight or dewing condition. To store products on the shelf and avoid exposure to moisture.

### DISCLAIMER

NextGen Component, Inc. reserves the right to make changes to the product(s) and or information contained herein without notice. No liability is assumed as a result of their use or application. No rights under any patent accompany the sale of any such product(s) or information