



SPECIFICATION SHEET

| | |
|--------------------------------|---|
| SPECIFICATION SHEET NO. | Q0620- 0402N8R2C500HI |
| DATE | June 20, 2023 |
| REVISION | A3 |
| DESCRIPTION | Multilayer Ceramic Chip Capacitors 0402 (1005 Metric) Series, L1.00*W0.50*H0.50mm, Thickness: 0.70mm Max. Dielectric NP0, Capacitance 8.2pF, Tolerance ±0.25pF, Rated Voltage 50V Operating Temp. Range -55°C ~+125°C Package in Tape/Reel, 10,000pcs/Reel RoHS/RoHS III compliant |
| CUSTOMER | |
| CUSTOMER PART NUMBER | |
| CROSS REF. PART NUMBER | |
| ORIGINAL PART NUMBER | Aillen 0402N8R2C500HI |
| PART CODE | 0402N8R2C500HI |

| | | | |
|-------------------------|---|--|---|
| VENDOR APPROVE | | | |
| Issued/Checked/Approved |  |  |  |
| DATE: June 20, 2023 | | | |

| | |
|-------------------------|--|
| CUSTOMER APPROVE | |
| | |
| DATE: | |
| 6/20/2023 | |

MULTILAYER CERAMIC CHIP CAPACITORS 0402 SERIES

MAIN FEATURE

MLCC consists of a conducting material and electrodes. To manufacture a chip-type SMT and achieve miniaturization, high density and high efficiency, ceramic condensers are used. MLCC is made by NP0, X7R, X6S, X5R and Y5V dielectric material and which provides product with high electrical precision, stability and reliability.

MAIN FEATURE

- RoHS III Compliant • Wide Operating Temperature Range -55~+125°C • High capacitance in given case size
- A wide selection of sizes is available (0201 to 1812) • Capacitor with lead-free termination (pure Tin)

APPLICATION

- General Digital Circuit • Power Supply by pass capacitors • Consumer Electronics • Telecommunication

RFQ
Request For Quotation

PART CODE GUIDE

| Code | Name | Key Specification Option |
|-------------|------------------|---|
| 0402 | Size | 0201 (0603): L0.60*W0.30mm; 0402 (1005): L1.00*W0.50mm 0603 (1608): L1.60*W0.80mm; 0805 (2012): L2.00*W1.25mm 1206 (3216): L3.20*W1.60mm; 1210 (3225): L3.20*W2.50mm 1812 (4532): L4.50*W3.20mm |
| N | Dielectric | N: NP0 (COG) ; B: X7R; Y: Y5V; W: X5R; S: X6S |
| 8R2 | Capacitance | Two significant digits followed by number of Zero, The 3rd digit signifies the multiplying factor, and letter R is decimal point. 0R5: 0.5pF; 8R2: 8.2pF ; 104: 100nF; 100: 10pF |
| C | Tolerance | A=±0.05pF; B=±0.1pF; C=±0.25pF ; D=±0.5pF; F=±1%; G=±2%; J=±5%; K=±10% M=±20%; Z=-20/+80% |
| 500 | Rated Voltage | Two significant digits followed by No. of zeros. "R" is in place of decimal point. 4R0=4 VDC; 6R3=6.3 VDC; 100=10 VDC; 160=16 VDC; 250=25 VDC; 500=50 VDC ; 101 =100 VDC |
| H | Thickness | H: 0.50±0.20mm, See Table 1 |
| I | Package | K: 0.5 Kpcs/Reel; A: 1Kpcs/Reel; B: 2Kpcs/Reel; C: 3Kpcs/Reel; D: 4Kpcs/Reel; E: 15Kpcs/Reel; I: 10Kpcs/Reel ; J: 2.5Kpcs/Reel; F: others |
| | Internal Control | Internal Code: Letter + Number; Blank: N/A; |

MULTILAYER CERAMIC CHIP CAPACITORS 0402 SERIES
DIMENSION (Unit: mm)

Image for reference

Table 1

| Size Code | L | W | T (Symbol) | Soldering Method | M B |
|-----------------------|-----------|-----------|--|-----------------------------|-------------------------|
| 0201 (0603) | 0.6±0.09 | 0.30±0.09 | 0.3±0.09 (L) | R | 0.15+0.1/-0.05 |
| 0402 (1005) | 1.00±0.20 | 0.50±0.20 | 0.50±0.05 (N); 0.50±0.20 (H) | R | 0.25+0.05/-0.10 |
| 0603 (1608) | 1.60±0.20 | 0.80±0.20 | 0.50±0.20 (H); 0.80±0.10 (S) 0.85±0.15 (B); 0.80±0.20 (X) | R/W | 0.40±0.15 |
| 0805 (2012) | 2.00±0.20 | 1.25±0.20 | 0.50±0.20 (H); 0.60±0.10 (A) 0.85±0.15 (B); 0.80±0.20 (X) 1.25±0.20 (C) | H & C: R A, X & B: R/W | 0.50±0.20 |
| 1206 (3216) | 3.20±0.30 | 1.60±0.30 | 0.85±0.15 (B); 0.95±0.10 (I) 1.25±0.20 (C); 1.15±0.20 (J) 1.60±0.20 (D); 1.60+0.30/-0.10 (P) | B: R/W C, D, I, J & P: R | 0.60±0.20 0.50±0.25 |
| 1210 (3225) | 3.20±0.40 | 2.50±0.30 | 0.85±0.15 (B); 0.95±0.10 (I) 1.25±0.20 (C); 1.60±0.20 (D); 2.00±0.20 (K); 2.50±0.30 (M) | R | 0.75±0.25 |
| 1812 (4532) | 4.50±0.40 | 3.20±0.40 | 1.25±0.20 (C); 1.60±0.20 (D); 2.00±0.20 (K); 2.50±0.30 (M) 2.80±0.30 (U) | R | 0.75±0.25 0.50±0.25* |

MULTILAYER CERAMIC CHIP CAPACITORS 0402 SERIES
GENERAL ELECTRONICAL CHARACTERISTICS
Table 2

| Dielectric | NPO | X7R | Y5V | X5R | X6S |
|----------------------------|--|-----------------------------------|---------------------------|-----------------------|-----------------------|
| Size | 0201, 0402, 0603, 0805, 1206, 1210, 1812 | | | | |
| Capacitance range* | 0.1pF to 0.1μF | 100pF to 47μF | 0.01μF to 100μF | 100pF to 220μF | 0.1μF to 100μF |
| Capacitance Tolerance | Cap. ≤5pF (Note #1): A (±0.05pF), B (±0.1pF), C (±0.25pF) 5pF < Cap < 10pF: C (±0.25pF), D (±0.5pF) Cap ≥ 10pF: F (±1%), G (±2%), J (±5%), K (±10%) | J (±5%), K (±10%), M (±20%) | M (±20%), Z (-20/+80%) | K (±10%), M (±20%) | K (±10%), M (±20%) |
| Rated Voltage | 10V, 16V, 25V, 50V, 100V | 6.3V, 10V, 16V, 25V, 50V, 100V | | | |
| Operating Temperature | -55 ~ +125°C | | -25 ~ +85°C | -55 ~ +85°C | -55 ~ +105°C |
| Capacitance Characteristic | ±30ppm | ±15% | +30/-80% | ±15% | ±22% |
| Termination | Ni/Sn (lead-free termination) | | | | |

Note:

- #1: NPO, 0.1pF product only provide B tolerance; 0603N0R4 provide B&C tolerance; 0603N0R3 only provide C tolerance.
- * Measured at the condition of 30~70% related humidity.
- NPO: Apply 1.0±0.2Vrms, 1.0MHz±10% for Cap ≤ 1000pF and 1.0±0.2Vrms, 1.0kHz±10% for Cap > 1000pF, 25°C at ambient temperature.
- X7R/X6S/X5R/X6S: Please refer to “Reliability test conditions and requirements” for detail.
- Y5V: Apply 1.0±0.2Vrms, 1.0kHz±10%, at 20°C ambient temperature.
- ** Preconditioning for Class II MLCC: Perform a heat treatment at 150±10°C for 1 hour and then leave in ambient condition for 24±2 hours before measurement.

MULTILAYER CERAMIC CHIP CAPACITORS 0402 SERIES
X7R
Table 3

| Rated vol. | D.F. ≤ | Exception of D.F. ≤ | |
|------------|--------|---------------------|--|
| | | ≤ 3% | 1206 ≥ 0.47μF |
| ≥100V | ≤ 2.5% | ≤ 5% | 0603 ≥ 0.068μF; 0805 > 0.1μF; 1206 ≥ 1μF; 1210 ≥ 2.2μF; |
| | | ≤ 10% | 0805 > 0.22μF; 1210 ≥ 3.3μF |
| | | ≤ 3% | 1206 ≥ 0.47μF |
| 50V | ≤ 2.5% | ≤ 5% | 0201 ≥ 0.01μF; 1210 ≥ 4.7μF |
| | | ≤ 10% | 0402 ≥ 0.012μF; 0603 > 0.1μF; 0805/X7R > 0.47μF; 1206 ≥ 2.2μF; 1210 ≥ 10μF; |
| | | ≤ 3% | 0201(50V); 0603 ≥ 0.047μF; 0805 ≥ 0.18μF; 1206 ≥ 0.47μF |
| 35V | ≤ 3.5% | ≤ 10% | 0603 ≥ 1μF; 0805 ≥ 2.2μF; 1206 ≥ 2.2μF; 1210 ≥ 10μF |
| 25V | ≤ 3.5% | ≤ 5% | 0201 ≥ 0.01μF; 0805 ≥ 1μF; 1210/X7R ≥ 10μF |
| | | ≤ 7% | 0603 ≥ 0.33μF |
| | | ≤ 10% | 0201 ≥ 0.1μF; 0402/X7R ≥ 0.056μF; 0603 ≥ 0.47μF; 0805 ≥ 2.2μF; 1206 ≥ 4.7μF; 1210 ≥ 22μF |
| | | ≤ 12.5% | 0402 ≥ 0.47μF |
| 16V | ≤ 3.5% | ≤ 5% | 0201 ≥ 0.01μF; 0402 ≥ 0.033μF; 0603 ≥ 0.15μF; 0805 ≥ 0.68μF; 1206 ≥ 2.2μF; 1210 ≥ 4.7μF |
| | | ≤ 10% | 0201/X7R ≥ 0.022μF; 0402 ≥ 0.22μF; 0603 > 0.47μF; 0805 ≥ 2.2μF; 1206 ≥ 4.7μF; 1210 ≥ 22μF; |
| 10V | ≤ 5.0% | ≤ 10% | 0201 ≥ 0.012μF; 0402 ≥ 0.22μF; 0603 ≥ 0.33μF; 0805 ≥ 2.2μF; 1206 ≥ 2.2μF; 1210 ≥ 22μF |
| | | ≤ 15% | 0201 ≥ 0.1μF; 0402 ≥ 1μF |
| 6.3V | ≤ 10% | ≤ 15% | 0201 ≥ 0.1μF; 0402 ≥ 1μF; 0603 ≥ 10μF; 0805 ≥ 4.7μF; 1206 ≥ 47μF; 1210 ≥ 100μF |
| | | ≤ 20% | 0402 ≥ 2.2μF |
| 4V | ≤ 15% | - | - |

MULTILAYER CERAMIC CHIP CAPACITORS 0402 SERIES
X5R
Table 4

| Rated vol. | D.F. \leq | Exception of D.F. \leq | |
|-------------|--------------|--------------------------|---|
| | | | |
| $\geq 100V$ | $\leq 2.5\%$ | $\leq 3\%$ | 1206 $\geq 0.47\mu F$ |
| | | $\leq 5\%$ | 0603 $\geq 0.068\mu F$; 0805 $> 0.1\mu F$; 1206 $\geq 1\mu F$; 1210 $\geq 2.2\mu F$; |
| | | $\leq 10\%$ | 0805 $> 0.22\mu F$; 1210 $\geq 3.3\mu F$ |
| 50V | $\leq 2.5\%$ | $\leq 3\%$ | 0201(50V); 0603 $\geq 0.047\mu F$; 0805 $\geq 0.18\mu F$; 1206 $\geq 0.47\mu F$ |
| | | $\leq 5\%$ | 0201 $\geq 0.01\mu F$; 1210 $\geq 4.7\mu F$ |
| | | $\leq 10\%$ | 0402 $\geq 0.012\mu F$; 0603 $> 0.1\mu F$; 0805 $\geq 1\mu F$; 1206 $\geq 2.2\mu F$; 1210 $\geq 10\mu F$; |
| 35V | $\leq 3.5\%$ | $\leq 10\%$ | 0603 $\geq 1\mu F$; 0805 $\geq 2.2\mu F$; 1206 $\geq 2.2\mu F$; 1210 $\geq 10\mu F$ |
| 25V | $\leq 3.5\%$ | $\leq 5\%$ | 0201 $\geq 0.01\mu F$; 0805 $\geq 1\mu F$; 1210/X5R $\geq 10\mu F$ |
| | | $\leq 7\%$ | 0603 $\geq 0.33\mu F$ |
| | | $\leq 10\%$ | 0201 $\geq 0.1\mu F$; 0402 $\geq 0.10\mu F$; 0603 $\geq 0.47\mu F$; 0805 $\geq 2.2\mu F$; 1206 $\geq 4.7\mu F$; 1210/X5R $\geq 10\mu F$; |
| | | $\leq 12.5\%$ | 0402 $\geq 0.47\mu F$ |
| 16V | $\leq 3.5\%$ | $\leq 5\%$ | 0201 $\geq 0.01\mu F$; 0402 $\geq 0.033\mu F$; 0603 $\geq 0.15\mu F$; 0805 $\geq 0.68\mu F$; 1206 $\geq 2.2\mu F$; 1210 $\geq 4.7\mu F$ |
| | | $\leq 10\%$ | 0201 $\geq 0.1\mu F$; 0402 $\geq 0.22\mu F$; 0603 $> 0.47\mu F$; 0805 $\geq 2.2\mu F$; 1206 $\geq 4.7\mu F$; 1210 $\geq 22\mu F$ |
| 10V | $\leq 5.0\%$ | $\leq 10\%$ | 0201 $\geq 0.012\mu F$; 0402 $\geq 0.22\mu F$; 0603 $\geq 0.33\mu F$; 0805 $\geq 2.2\mu F$; 1206 $\geq 2.2\mu F$; 1210 $\geq 22\mu F$ |
| | | $\leq 15\%$ | 0201 $\geq 0.1\mu F$; 0402 $\geq 1\mu F$ |
| 6.3V | $\leq 10\%$ | $\leq 15\%$ | 0201 $\geq 0.1\mu F$; 0402 $\geq 1\mu F$; 0603 $\geq 10\mu F$; 0805 $\geq 4.7\mu F$; 1206 $\geq 47\mu F$; 1210 $\geq 100\mu F$ |
| | | $\leq 20\%$ | 0402 $\geq 2.2\mu F$ |
| 4V | $\leq 15\%$ | - | - |

MULTILAYER CERAMIC CHIP CAPACITORS 0402 SERIES

Y5V

Table 5

| Rated vol. | D.F. ≤ | Exception of D.F. ≤ | |
|------------------|--------|---------------------|---|
| ≥50V | ≤5% | ≤7% | 0603≥0.1μF; 0805≥0.47μF; 1206≥4.7μF |
| | | ≤12.5% | 1210≥6.8μF |
| 35V | ≤7% | - | - |
| 25V | ≤5% | ≤7% | 0402≥0.047μF; 0603≥0.1μF; 0805≥0.33μF; 1206≥1μF; 1210≥4.7μF |
| | | ≤9% | 0402≥0.068μF; 0603≥0.47μF; 1206≥4.7μF; 1210≥22μF |
| 16V (C<1.0μF) | ≤7% | ≤9% | 0402≥0.068μF; 0603≥0.68μF |
| | | ≤12.5% | 0402≥0.22μF |
| 16V (C≥1.0μF) | ≤9% | ≤12.5% | 0603≥2.2μF; 0805≥3.3μF; 1206≥10μF; 1210≥22μF; 1812≥47μF |
| 10V | ≤12.5% | ≤20% | 0402≥0.47μF |
| 6.3V | ≤20% | - | - |

MULTILAYER CERAMIC CHIP CAPACITORS 0402 SERIES
X6S
Table 6

| Rated vol. | D.F. \leq | Exception of D.F. \leq | |
|-------------|--------------|--------------------------|---|
| $\geq 100V$ | $\leq 2.5\%$ | $\leq 3\%$ | 1206 $\geq 0.47\mu F$ |
| | | $\leq 5\%$ | 0603 $\geq 0.068\mu F$; 0805 $> 0.1\mu F$; 1206 $\geq 1\mu F$; 1210 $\geq 2.2\mu F$; |
| | | $\leq 10\%$ | 0805 $> 0.22\mu F$; 1210 $\geq 3.3\mu F$ |
| 50V | $\leq 2.5\%$ | $\leq 3\%$ | 0201(50V); 0603 $\geq 0.047\mu F$; 0805 $\geq 0.18\mu F$; 1206 $\geq 0.47\mu F$ |
| | | $\leq 5\%$ | 0201 $\geq 0.01\mu F$; 1210 $\geq 4.7\mu F$ |
| | | $\leq 10\%$ | 0402 $\geq 0.012\mu F$; 0603 $> 0.1\mu F$; 0805 $\geq 1\mu F$; 1206 $\geq 2.2\mu F$; 1210 $\geq 10\mu F$; |
| 35V | $\leq 3.5\%$ | $\leq 10\%$ | 0603 $\geq 1\mu F$; 0805 $\geq 2.2\mu F$; 1206 $\geq 2.2\mu F$; 1210 $\geq 10\mu F$ |
| 25V | $\leq 3.5\%$ | $\leq 5\%$ | 0201 $\geq 0.01\mu F$; 0805 $\geq 1\mu F$; 1210/X6S $\geq 10\mu F$ |
| | | $\leq 7\%$ | 0603 $\geq 0.33\mu F$ |
| | | $\leq 10\%$ | 0201 $\geq 0.1\mu F$; 0402 $\geq 0.10\mu F$; 0603 $\geq 0.47\mu F$; 0805 $\geq 2.2\mu F$; 1206 $\geq 4.7\mu F$; 1210 $\geq 22\mu F$; |
| | | $\leq 12.5\%$ | 0402 $\geq 0.47\mu F$ |
| 16V | $\leq 3.5\%$ | $\leq 5\%$ | 0201 $\geq 0.01\mu F$; 0402 $\geq 0.033\mu F$; 0603 $\geq 0.15\mu F$; 0805 $\geq 0.68\mu F$; 1206 $\geq 2.2\mu F$; 1210 $\geq 4.7\mu F$ |
| | | $\leq 10\%$ | 0201 $\geq 0.1\mu F$; 0402 $\geq 0.22\mu F$; 0603 $> 0.47\mu F$; 0805 $\geq 2.2\mu F$; 1206 $\geq 4.7\mu F$; 1210 $\geq 22\mu F$ |
| 10V | $\leq 5.0\%$ | $\leq 10\%$ | 0201 $\geq 0.012\mu F$; 0402 $\geq 0.22\mu F$; 0603 $\geq 0.33\mu F$; 0805 $\geq 2.2\mu F$; 1206 $\geq 2.2\mu F$; 1210 $\geq 22\mu F$ |
| | | $\leq 15\%$ | 0201 $\geq 0.1\mu F$; 0402 $\geq 1\mu F$ |
| 6.3V | $\leq 10\%$ | $\leq 15\%$ | 0201 $\geq 0.1\mu F$; 0402/X6S $\geq 0.47\mu F$; 0603 $\geq 10\mu F$; 0805 $\geq 4.7\mu F$; 1206 $\geq 47\mu F$; 1210 $\geq 100\mu F$ |
| | | $\leq 20\%$ | 0402 $\geq 2.2\mu F$ |
| 4V | $\leq 15\%$ | - | - |

MULTILAYER CERAMIC CHIP CAPACITORS 0402 SERIES
CAPACITANCE RANGE - NPO DIELECTRIC 0201, 0402, 0603 SIZES
Table 7-A

| Size | 0201 | | | 0402 | | | | | 0603 | | | | | |
|-------------|---------|----|----|------|----|----|----|----|------|----|----|-----|----|-----|
| | VDC (V) | 16 | 25 | 50 | 10 | 16 | 25 | 50 | 100 | 10 | 16 | 25 | 50 | 100 |
| 0.1pF (0R1) | L | L | L | H | H | H | H | | | | | | | |
| 0.2pF (0R2) | L | L | L | H | H | H | H | | | | | | | |
| 0.3pF (0R3) | L | L | L | H | H | H | H | | | | | | | |
| 0.4pF (0R4) | L | L | L | H | H | H | H | | | | | | | |
| 0.5pF (0R5) | L | L | L | H | H | H | H | H | S | S | S | S | S | S |
| 0.6pF (0R6) | L | L | L | H | H | H | H | H | S | S | S | S | S | S |
| 0.7pF (0R7) | L | L | L | H | H | H | H | H | S | S | S | S | S | S |
| 0.8pF (0R8) | L | L | L | H | H | H | H | H | S | S | S | S | S | S |
| 0.9pF (0R9) | L | L | L | H | H | H | H | H | S | S | S | S | S | S |
| 1.0pF (1R0) | L | L | L | H | H | H | H | H | S | S | S | S | S | S |
| 1.2pF (1R2) | L | L | L | H | H | H | H | H | S | S | S | S | S | S |
| 1.5pF (1R5) | L | L | L | H | H | H | H | H | S | S | S | S/B | S | S |
| 1.6pF (1R6) | | | | | | | H | | | | | | | |
| 1.8pF (1R8) | L | L | L | H | H | H | H | H | S | S | S | S | S | S |
| 2.0pF (2R0) | L | L | L | H | H | H | H | H | S | S | S | S | S | S |
| 2.2pF (2R2) | L | L | L | H | H | H | H | H | S | S | S | S | S | S |
| 2.7pF (2R7) | L | L | L | H | H | H | H | H | S | S | S | S | S | S |
| 3.0pF (3R0) | L | L | L | H | H | H | H | H | S | S | S | S | S | S |
| 3.3pF (3R3) | L | L | L | H | H | H | H | H | S | S | S | S | S | S |
| 3.9pF (3R9) | L | L | L | H | H | H | H | H | S | S | S | S/B | S | S |
| 4.0pF (4R0) | L | L | L | H | H | H | H | H | S | S | S | S | S | S |
| 4.7pF (4R7) | L | L | L | H | H | H | H | H | S | S | S | S/B | S | S |
| 5.0pF (5R0) | L | L | L | H | H | H | H | H | S | S | S | S | S | S |
| 5.6pF (5R6) | L | L | L | H | H | H | H | H | S | S | S | S/B | S | S |
| 6.0pF (6R0) | L | L | L | H | H | H | H | H | S | S | S | S | S | S |
| 6.8pF (6R8) | L | L | L | H | H | H | H | H | S | S | S | S | S | S |
| 7.0pF (7R0) | L | L | L | H | H | H | H | H | S | S | S | S/B | S | S |
| 8.0pF (8R0) | L | L | L | H | H | H | H | H | S | S | S | S | S | S |
| 8.2pF (8R2) | L | L | L | H | H | H | H | H | S | S | S | S/B | S | S |
| 9.0pF (9R0) | L | L | L | H | H | H | H | H | S | S | S | S | S | S |

MULTILAYER CERAMIC CHIP CAPACITORS 0402 SERIES
CAPACITANCE RANGE - NPO DIELECTRIC 0201, 0402, 0603 SIZES
Table 7-B

| Size | 0201 | | | 0402 | | | | | 0603 | | | | | |
|---------------|---------|----|----|------|----|----|-----|----|------|----|----|-----|-----|-----|
| | VDC (V) | 16 | 25 | 50 | 10 | 16 | 25 | 50 | 100 | 10 | 16 | 25 | 50 | 100 |
| 10pF (100) | L | L | L | H | H | H | H | H | H | S | S | S | S | S |
| 12pF (120) | L | L | L | H | H | H | H | H | H | S | S | S | S | S |
| 15pF (150) | L | L | L | H | H | H | H | H | H | S | S | S | S/B | S |
| 18pF (180) | L | L | L | H | H | H | H | H | H | S | S | S | S/B | S |
| 22pF (220) | L | L | L | H | H | H | H/N | H | H | S | S | S | S/B | S |
| 27pF (270) | L | L | L | H | H | H | H | H | H | S | S | S | S | S |
| 30pF (300) | | | | | | H | | | | | | | | |
| 33pF (330) | L | L | L | H | H | H | H | H | H | S | S | S/B | S/B | S |
| 39pF (390) | L | L | L | H | H | H | H | H | H | S | S | S | S | S |
| 47pF (470) | L | L | L | H | H | H | H | H | H | S | S | S | S/B | S |
| 56pF (560) | L | L | L | H | H | H | H | H | H | S | S | S | S | S |
| 68pF (680) | L | L | L | H | H | H | H | H | H | S | S | S | S | S |
| 82pF (820) | L | L | L | H | H | H | H | H | H | S | S | S | S | S |
| 100pF (101) | L | L | L | H | H | H | H/N | H | H | S | S | S | S/B | S |
| 120pF (121) | L | L | L | H | H | H | H | H | H | S | S | S | S/B | S |
| 150pF (151) | L | L | L | H | H | H | H | H | H | S | S | S | S | S |
| 180pF (181) | | | | H | H | H | H | H | H | S | S | S | S | S |
| 220pF (221) | | | | H | H | H | H | H | H | S | S | S | S | S |
| 270pF (271) | L | | | H | H | H | H | | | S | S | S | S/B | S |
| 330pF (331) | L | | | H | H | H | H | | | S | S | S | S/B | S |
| 390pF (391) | L | | | H | H | H | H | | | S | S | S | S | S |
| 470pF (471) | L | | | H | H | H | H | | | S | S | S | S | S |
| 560pF (561) | L | | | H | H | H | H | | | S | S | S | S | S |
| 680pF (681) | | | | H | H | H | H | | | S | S | S | S | S |
| 820pF (821) | | | | H | H | H | H | | | S | S | S | S | S |
| 1,000pF (102) | | | | H | H | H | H | | | S | S | S/B | S | S |
| 1,200pF (122) | | | | | | | | | | X | X | X | X | X |
| 1,500pF (152) | | | | | | | | | | X | X | X | X | X |
| 1,800pF (182) | | | | | | | | | | X | X | X | X | |

MULTILAYER CERAMIC CHIP CAPACITORS 0402 SERIES
CAPACITANCE RANGE - NP0 DIELECTRIC 0603 SIZES
Table 7-C

| Size | 0603 | | | |
|---------------|------|----|----|-----|
| | 10 | 16 | 25 | 50 |
| VDC (V) | 10 | 16 | 25 | 50 |
| 2,200pF (222) | X | X | X | X/B |
| 2,700pF (272) | X | X | X | X/B |
| 3,300pF (332) | X | X | X | X |
| 3,900pF (392) | X | X | X | X |
| 4,700pF (472) | X | X | X | X |
| 5,600pF (562) | X | X | X | X |
| 6,800pF (682) | X | X | X | X |
| 8,200pF (822) | X | X | X | X |
| 0.010μF (103) | X | X | X | X |

CAPACITANCE RANGE - NP0 DIELECTRIC 0805, 1206 SIZES
Table 7-D

| Size | 0805 | | | | | 1206 | | | | |
|-------------|------|----|----|----|-----|------|----|----|----|-----|
| | 10 | 16 | 25 | 50 | 100 | 10 | 16 | 25 | 50 | 100 |
| VDC (V) | 10 | 16 | 25 | 50 | 100 | 10 | 16 | 25 | 50 | 100 |
| 0.5pF (0R5) | A | A | A | A | A | | | | | |
| 0.6pF (0R6) | A | A | A | A | A | | | | | |
| 0.7pF (0R7) | A | A | A | A | A | | | | | |
| 0.8pF (0R8) | A | A | A | A | A | | | | | |
| 0.9pF (0R9) | A | A | A | A | A | | | | | |
| 1.0pF (1R0) | A | A | A | A | A | | | | B | |
| 1.2pF (1R2) | A | A | A | A | A | B | B | B | B | B |
| 1.5pF (1R5) | A | A | A | A | A | B | B | B | B | B |
| 1.8pF (1R8) | A | A | A | A | A | B | B | B | B | B |
| 2.0pF (2R0) | A | A | A | A | A | | | | | |
| 2.2pF (2R2) | A | A | A | A | A | B | B | B | B | B |
| 2.7pF (2R7) | A | A | A | A | A | B | B | B | B | B |
| 3.0pF (3R0) | A | A | A | A | A | | | | | |
| 3.3pF (3R3) | A | A | A | A | A | B | B | B | B | B |
| 3.9pF (3R9) | A | A | A | A | A | B | B | B | B | B |
| 4.0pF (4R0) | A | A | A | A | A | | | | | |

MULTILAYER CERAMIC CHIP CAPACITORS 0402 SERIES

CAPACITANCE RANGE - NP0 DIELECTRIC 0805, 1206 SIZES

Table 7-E

| Size | 0805 | | | | | 1206 | | | | |
|-------------|------|----|----|----|-----|------|----|----|----|-----|
| | 10 | 16 | 25 | 50 | 100 | 10 | 16 | 25 | 50 | 100 |
| VDC (V) | | | | | | | | | | |
| 4.7pF (4R7) | A | A | A | A | A | B | B | B | B | B |
| 5.0pF (5R0) | A | A | A | A | A | | | | | |
| 5.6pF (5R6) | A | A | A | A | A | B | B | B | B | B |
| 6.0pF (6R0) | A | A | A | A | A | | | | | |
| 6.8pF (6R8) | A | A | A | A | A | B | B | B | B | B |
| 7.0pF (7R0) | A | A | A | A | A | B | B | B | B | B |
| 8.0pF (8R0) | A | A | A | A | A | | | | | |
| 8.2pF (8R2) | A | A | A | A | A | B | B | B | B | B |
| 9.0pF (9R0) | A | A | A | A | A | | | | | |
| 10pF (100) | A | A | A | A | A | B | B | B | B | B |
| 12pF (120) | A | A | A | A | A | | | | | |
| 15pF (150) | A | A | A | A | A | B | B | B | B | B |
| 18pF (180) | A | A | A | A | A | B | B | B | B | B |
| 22pF (220) | A | A | A | A | A | B | B | B | B | B |
| 27pF (270) | A | A | A | A | A | B | B | B | B | B |
| 33pF (330) | A | A | A | A | A | B | B | B | B | B |
| 39pF (390) | A | A | A | A | A | B | B | B | B | B |
| 47pF (470) | A | A | A | A | A | B | B | B | B | B |
| 56pF (560) | A | A | A | A | A | B | B | B | B | B |
| 68pF (680) | A | A | A | A | A | B | B | B | B | B |
| 82pF (820) | A | A | A | A | A | B | B | B | B | B |
| 100pF (101) | A | A | A | A | A | B | B | B | B | B |
| 120pF (121) | A | A | A | A | A | B | B | B | B | B |
| 150pF (151) | A | A | A | A | A | B | B | B | B | B |
| 180pF (181) | A | A | A | A | A | B | B | B | B | B |
| 220pF (221) | A | A | A | A | A | B | B | B | B | B |
| 270pF (271) | A | A | A | A | A | B | B | B | B | B |
| 330pF (331) | A | A | A | A | A | B | B | B | B | B |
| 390pF (391) | B | B | B | B | B | B | B | B | B | B |
| 470pF (471) | B | B | B | B | B | | | | | |

MULTILAYER CERAMIC CHIP CAPACITORS 0402 SERIES
CAPACITANCE RANGE - NPO DIELECTRIC 0805, 1206 SIZES
Table 7-F

| Size | 0805 | | | | | 1206 | | | | | |
|---------------|---------|----|----|----|----|------|----|----|----|----|-----|
| | VDC (V) | 10 | 16 | 25 | 50 | 100 | 10 | 16 | 25 | 50 | 100 |
| 560pF (561) | B | B | B | B | B | B | B | B | B | B | B |
| 680pF (681) | B | B | B | B | B | B | B | B | B | B | B |
| 820pF (821) | B | B | B | B | B | B | B | B | B | B | B |
| 1,000pF (102) | B | B | B | B | B | B | B | B | B | B | B |
| 1,200pF (122) | B | B | B | B | B | B | B | B | B | B | B |
| 1,500pF (152) | B | B | B | B | B | B | B | B | B | B | B |
| 1,800pF (182) | B | B | B | B | B | B | B | B | B | B | B |
| 2,200pF (222) | B | B | B | B | B | B | B | B | B | B | B |
| 2,700pF (272) | C | C | C | C | C | B | B | B | B | B | B |
| 3,300pF (332) | C | C | C | C | C | B | B | B | B | B | B |

CAPACITANCE RANGE - NPO DIELECTRIC 0805, 1206 SIZES
Table 7-G

| Size | 0805 | | | | | 1206 | | | | | |
|---------------|---------|----|----|----|----|------|----|----|----|----|-----|
| | VDC (V) | 10 | 16 | 25 | 50 | 100 | 10 | 16 | 25 | 50 | 100 |
| 3,900pF (392) | C | C | C | C | C | C | B | B | B | B | B |
| 4,700pF (472) | C | C | C | C | C | C | B | B | B | B | B |
| 5,600pF (562) | C | C | C | C | C | C | B | B | B | B | B |
| 6,800pF (682) | C | C | C | C | C | C | I | I | I | I | I |
| 8,200pF (822) | C | C | C | C | C | C | C | C | C | C | C |
| 0.010μF (103) | C | C | C | C | C | C | C | C | C | C | C |
| 0.012μF (123) | B | B | B | B | B | B | P | P | P | P | P |
| 0.015μF (153) | | | | | | | P | P | P | P | P |
| 0.018μF (183) | C | C | C | C | C | C | P | P | P | P | P |
| 0.022μF (223) | C | C | C | C | C | C | P | P | P | P | P |
| 0.027μF (273) | | | | | | | P | P | P | P | |
| 0.033μF (333) | | | | | | | P | P | P | P | |
| 0.039μF (393) | | | | | | | P | P | P | P | |
| 0.047μF (473) | | | | | | | J | J | J | J | |
| 0.056μF (563) | | | | | | | J | J | J | J | |
| 0.068μF (683) | | | | | | | D | D | D | D | |

MULTILAYER CERAMIC CHIP CAPACITORS 0402 SERIES
CAPACITANCE RANGE - NP0 DIELECTRIC 0805, 1206 SIZES
Table 7-H

| Size | 0805 | | | | | 1206 | | | | |
|---------------|------|----|----|----|-----|------|----|----|----|-----|
| VDC (V) | 10 | 16 | 25 | 50 | 100 | 10 | 16 | 25 | 50 | 100 |
| 0.082μF (823) | | | | | | D | D | D | D | |
| 0.1μF (104) | | | | | | D | D | D | D | |

CAPACITANCE RANGE - NP0 DIELECTRIC 1210, 1812 SIZES
Table 7-I

| Size | 1210 | | | | | 1812 | | |
|---------------|------|----|----|----|-----|------|----|-----|
| VDC (V) | 10 | 16 | 25 | 50 | 100 | 16 | 50 | 100 |
| 10pF (100) | I | I | I | I | I | C | C | C |
| 15pF (150) | I | I | I | I | I | C | C | C |
| 18pF (180) | I | I | I | I | I | C | C | C |
| 22pF (220) | I | I | I | I | I | C | C | C |
| 27pF (270) | I | I | I | I | I | C | C | C |
| 33pF (330) | I | I | I | I | I | C | C | C |
| 39pF (390) | I | I | I | I | I | C | C | C |
| 47pF (470) | I | I | I | I | I | C | C | C |
| 56pF (560) | I | I | I | I | I | C | C | C |
| 68pF (680) | I | I | I | I | I | C | C | C |
| 82pF (820) | I | I | I | I | I | C | C | C |
| 100pF (101) | I | I | I | I | I | C | C | C |
| 120pF (121) | I | I | I | I | I | C | C | C |
| 150pF (151) | I | I | I | I | I | C | C | C |
| 180pF (181) | I | I | I | I | I | C | C | C |
| 220pF (221) | I | I | I | I | I | C | C | C |
| 270pF (271) | I | I | I | I | I | C | C | C |
| 330pF (331) | I | I | I | I | I | C | C | C |
| 390pF (391) | I | I | I | I | I | C | C | C |
| 560pF (561) | I | I | I | I | I | C | C | C |
| 680pF (681) | I | I | I | I | I | C | C | C |
| 820pF (821) | I | I | I | I | I | C | C | C |
| 1,000pF (102) | I | I | I | I | I | C | C | C |
| 1,200pF (122) | I | I | I | I | I | C | C | C |

MULTILAYER CERAMIC CHIP CAPACITORS 0402 SERIES
CAPACITANCE RANGE - NP0 DIELECTRIC 1210, 1812 SIZES
Table 7-J

| Size | 1210 | | | | | 1812 | | |
|---------------|------|----|----|----|-----|------|----|-----|
| VDC (V) | 10 | 16 | 25 | 50 | 100 | 16 | 50 | 100 |
| 1,500pF (152) | I | I | I | I | I | C | C | C |
| 1,800pF (182) | I | I | I | I | I | C | C | C |
| 2,200pF (222) | I | I | I | I | I | C | C | C |
| 2,700pF (272) | I | I | I | I | I | C | C | C |
| 3,300pF (332) | I | I | I | I | I | C | C | C |
| 3,900pF (392) | I | I | I | I | I | C | C | C |
| 4,700pF (472) | I | I | I | I | I | C | C | C |
| 5,600pF (562) | I | I | I | I | I | C | C | C |
| 6,800pF (682) | I | I | I | I | I | C | C | C |
| 8,200pF (822) | I | I | I | I | I | C | C | C |
| 0.010μF (103) | I | I | I | I | I | C | C | C |
| 0.012μF (123) | C | C | C | C | C | C | C | C |
| 0.015μF (153) | C | C | C | C | C | C | C | C |
| 0.018μF (183) | | K | K | K | K | C | C | C |
| 0.022μF (223) | | K | K | K | K | C | C | C |
| 0.027μF (273) | | K | K | K | K | C | C | C |
| 0.033μF (333) | | K | K | K | K | C | C | C |
| 0.039μF (393) | | K | K | K | K | M | M | M |
| 0.047μF (473) | | K | K | K | K | M | M | M |
| 0.056μF (563) | | | | | | M | M | M |
| 0.068μF (683) | | | | | | M | M | M |
| 0.082μF (823) | | | | | | M | M | M |
| 0.1μF (104) | | | | | | M | M | M |

Note: The letter in cell is expressed the symbol of product thickness.

MULTILAYER CERAMIC CHIP CAPACITORS 0402 SERIES
CAPACITANCE RANGE – X7R DIELECTRIC 0201, 0402 SIZES
Table 8-A

| Size | 0201 | | | | | 0402 | | | | | |
|---------------|------|----|----|----|----|------|----|----|----|----|-----|
| VDC (V) | 6.3 | 10 | 16 | 25 | 50 | 6.3 | 10 | 16 | 25 | 50 | 100 |
| 100pF (101) | L | L | L | L | L | H | H | H | H | H | H |
| 120pF (121) | L | L | L | L | L | H | H | H | H | H | H |
| 150pF (151) | L | L | L | L | L | H | H | H | H | H | H |
| 180pF (181) | L | L | L | L | L | H | H | H | H | H | H |
| 220pF (221) | L | L | L | L | L | H | H | H | H | H | H |
| 270pF (271) | L | L | L | L | L | H | H | H | H | H | H |
| 330pF (331) | L | L | L | L | L | H | H | H | H | H | H |
| 390pF (391) | L | L | L | L | L | H | H | H | H | H | H |
| 470pF (471) | L | L | L | L | L | H | H | H | H | H | H |
| 560pF (561) | L | L | L | L | L | H | H | H | H | H | H |
| 680pF (681) | L | L | L | L | L | H | H | H | H | H | H |
| 820pF (821) | L | L | L | L | L | H | H | H | H | H | H |
| 1,000pF (102) | L | L | L | L | L | H | H | H | H | H | H |
| 1,200pF (122) | L | L | L | L | L | H | H | H | H | H | H |
| 1,500pF (152) | L | L | L | L | L | H | H | H | H | H | H |
| 1,800pF (182) | L | L | L | L | L | H | H | H | H | H | H |
| 2,200pF (222) | L | L | L | L | L | H | H | H | H | H | H |
| 2,700pF (272) | L | L | L | L | L | H | H | H | H | H | H |
| 3,300pF (332) | L | L | L | L | L | H | H | H | H | H | H |
| 3,900pF (392) | L | L | L | L | L | H | H | H | H | H | H |
| 4,700pF (472) | L | L | L | L | L | H | H | H | H | H | H |
| 5,600pF (562) | L | L | L | L | L | H | H | H | H | H | |
| 6,800pF (682) | L | L | L | L | L | H | H | H | H | H | |
| 8,200pF (822) | L | L | L | L | L | H | H | H | H | H | |
| 0.010μF (103) | L | L | L | L | L | H | H | H | H | H | |
| 0.012μF (123) | | | | | | H | H | H | H | H | |
| 0.015μF (153) | | | | | | H | H | H | H | H | |
| 0.018μF (183) | | | | | | H | H | H | H | H | |
| 0.022μF (223) | | | | | | H | H | H | H | H | |

MULTILAYER CERAMIC CHIP CAPACITORS 0402 SERIES
CAPACITANCE RANGE – X7R DIELECTRIC 0402 SIZES
Table 8-B

| Size | 0402 | | | | |
|---------------|------|----|----|----|----|
| VDC (V) | 6.3 | 10 | 16 | 25 | 50 |
| 0.027μF (273) | H | H | H | H | H |
| 0.033μF (333) | H | H | H | H | H |
| 0.039μF (393) | H | H | H | H | H |
| 0.047μF (473) | H | H | H | H | H |
| 0.056μF (563) | H | H | H | H | H |
| 0.068μF (683) | H | H | H | H | H |
| 0.082μF (823) | H | H | H | H | H |
| 0.10μF (104) | H | H | H | H | H |
| 0.22μF (224) | H | H | H | H | |
| 0.47μF (474) | H | H | | | |
| 1.0μF (105) | H | H | | | |

CAPACITANCE RANGE – X7R DIELECTRIC 0603, 0805 SIZES
Table 8-C

| Size | 0603 | | | | | | 0805 | | | | | |
|---------------|------|----|----|-----|-----|-----|------|----|----|----|----|-----|
| VDC (V) | 6.3 | 10 | 16 | 25 | 50 | 100 | 6.3 | 10 | 16 | 25 | 50 | 100 |
| 100pF (101) | S | S | S | S/B | S/B | S | B | B | B | B | B | B |
| 120pF (121) | S | S | S | S | S | S | B | B | B | B | B | B |
| 150pF (151) | S | S | S | S | S | S | B | B | B | B | B | B |
| 180pF (181) | S | S | S | S | S | S/B | B | B | B | B | B | B |
| 220pF (221) | S | S | S | S | S/B | S | B | B | B | B | B | B |
| 270pF (271) | S | S | S | S | S | S | B | B | B | B | B | B |
| 330pF (331) | S | S | S | S | S | S | B | B | B | B | B | B |
| 390pF (391) | S | S | S | S | S | S | B | B | B | B | B | B |
| 470pF (471) | S | S | S | S | S/B | S | B | B | B | B | B | B |
| 560pF (561) | S | S | S | S | S | S | B | B | B | B | B | B |
| 680pF (681) | S | S | S | S | S | S | B | B | B | B | B | B |
| 820pF (821) | S | S | S | S | S | S | B | B | B | B | B | B |
| 1,000pF (102) | S | S | S | S/B | S/B | S/B | B | B | B | B | B | B |
| 1,200pF (122) | S | S | S | S | S | S | B | B | B | B | B | B |
| 1,500pF (152) | S | S | S | S/B | S | S | B | B | B | B | B | B |

MULTILAYER CERAMIC CHIP CAPACITORS 0402 SERIES
CAPACITANCE RANGE – X7R DIELECTRIC 0603, 0805 SIZES
Table 8-D

| Size | 0603 | | | | | | 0805 | | | | | | |
|---------------|---------|-----|-----|-----|-----|----|------|-----|----|----|----|----|-----|
| | VDC (V) | 6.3 | 10 | 16 | 25 | 50 | 100 | 6.3 | 10 | 16 | 25 | 50 | 100 |
| 1,800pF (182) | S | S | S | S | S | S | S | B | B | B | B | B | B |
| 2,200pF (222) | S | S | S | S | S/B | S | S | B | B | B | B | B | B |
| 2,700pF (272) | S | S | S | S | S/B | S | S | B | B | B | B | B | B |
| 3,300pF (332) | S | S | S | S | S | S | S | B | B | B | B | B | B |
| 3,900pF (392) | S | S | S | S | S | S | S | B | B | B | B | B | B |
| 4,700pF (472) | S | S | S | S | S | S | S | B | B | B | B | B | B |
| 5,600pF (562) | S | S | S | S | S | S | S | B | B | B | B | B | B |
| 6,800pF (682) | S | S | S | S/B | S | S | S | B | B | B | B | B | B |
| 8,200pF (822) | S | S | S | S | S | S | S | B | B | B | B | B | B |
| 0.010μF (103) | S | S | S | S/B | S/B | S | S | B | B | B | B | B | B |
| 0.012μF (123) | S | S | S | S | S | X | X | B | B | B | B | B | B |
| 0.015μF (153) | S | S | S | S/B | S/B | X | X | B | B | B | B | B | B |
| 0.018μF (183) | S | S | S | S | S | X | X | B | B | B | B | B | B |
| 0.022μF (223) | S | S | S | S | S/B | X | X | B | B | B | B | B | B |
| 0.027μF (273) | S | S | S | S | S/B | X | X | B | B | B | B | B | C |
| 0.033μF (333) | S | S | S | S | X/B | X | X | B | B | B | B | B | C |
| 0.039μF (393) | S | S | S | S | X | X | X | B | B | B | B | B | C |
| 0.047μF (473) | S | S | S | S | X | X | X | B | B | B | B | B | C |
| 0.056μF (563) | S | S | S | S | X | X | X | B | B | B | B | B | C |
| 0.068μF (683) | S | S | S | S | X/B | X | X | B | B | B | B | B | C |
| 0.082μF (823) | S | S | S | S | X | X | X | B | B | B | B | B | C |
| 0.10μF (104) | S | S | S/B | S/B | X | X | X | B | B | B | B | B | C |
| 0.12μF (124) | S | S | S | X | | | | B | B | B | B | C | C |
| 0.15μF (154) | S | S | S/B | X | | | | C | C | C | C | C | C |
| 0.18μF (184) | S | S | S | X | | | | C | C | C | C | C | C |
| 0.22μF (224) | S | S | S/B | X/B | X | | | C | C | C | C | C | C |
| 0.27μF (274) | X | X | X | X | | | | C | C | C | C | C | |
| 0.33μF (334) | X | X | X | X | | | | C | C | C | C | C | |
| 0.39μF (394) | X | X | X | X | | | | C | C | C | C | C | |

MULTILAYER CERAMIC CHIP CAPACITORS 0402 SERIES
CAPACITANCE RANGE – X7R DIELECTRIC 0603, 0805 SIZES
Table 8-E

| Size | 0603 | | | | | 0805 | | | | | | |
|--------------|---------|-----|-----|-----|----|------|-----|----|----|----|----|-----|
| | VDC (V) | 6.3 | 10 | 16 | 25 | 50 | 6.3 | 10 | 16 | 25 | 50 | 100 |
| 0.47µF (474) | X | X | X/B | X/B | X | | C | C | C | C | C | C |
| 0.56µF (564) | X | X | X | | | | C | C | C | C | | |
| 0.68µF (684) | X | X | X | | | | C | C | C | C | | |
| 0.82µF (824) | X | X | X | | | | C | C | C | C | | |
| 1.0µF (105) | X | X | X | X | X | | C | C | C | C | C | |
| 1.5µF (155) | | | | | | | C | C | C | C | | |
| 2.2µF (225) | X | X/B | X | | | | C | C | C | C | C | |
| 4.7µF (475) | X | X | X | | | | C | C | C | C | | |
| 10µF (106) | | | | | | | C* | C* | C* | | | |

CAPACITANCE RANGE – X7R DIELECTRIC 1206, 1210 SIZES
Table 8-F

| Size | 1206 | | | | | | 1210 | | | | | |
|---------------|---------|-----|----|----|----|----|------|----|----|----|----|-----|
| | VDC (V) | 6.3 | 10 | 16 | 25 | 50 | 100 | 10 | 16 | 25 | 50 | 100 |
| 150pF (151) | B | B | B | B | B | B | B | | | | | |
| 180pF (181) | B | B | B | B | B | B | B | | | | | |
| 220pF (221) | B | B | B | B | B | B | B | | | | | |
| 270pF (271) | B | B | B | B | B | B | B | | | | | |
| 330pF (331) | B | B | B | B | B | B | B | | | | | |
| 390pF (391) | B | B | B | B | B | B | B | | | | | |
| 470pF (471) | B | B | B | B | B | B | B | | | | | |
| 560pF (561) | B | B | B | B | B | B | B | | | | | |
| 680pF (681) | B | B | B | B | B | B | B | | | | | |
| 820pF (821) | B | B | B | B | B | B | B | | | | | |
| 1,000pF (102) | B | B | B | B | B | B | B | I | I | I | I | I |
| 1,200pF (122) | B | B | B | B | B | B | B | I | I | I | I | I |
| 1,500pF (152) | B | B | B | B | B | B | B | I | I | I | I | I |
| 1,800pF (182) | B | B | B | B | B | B | B | I | I | I | I | I |
| 2,200pF (222) | B | B | B | B | B | B | B | I | I | I | I | I |
| 2,700pF (272) | B | B | B | B | B | B | B | I | I | I | I | I |
| 3,300pF (332) | B | B | B | B | B | B | B | I | I | I | I | I |

MULTILAYER CERAMIC CHIP CAPACITORS 0402 SERIES
CAPACITANCE RANGE – X7R DIELECTRIC 1206, 1210 SIZES
Table 8-G

| Size | 1206 | | | | | | 1210 | | | | | |
|---------------|---------|-----|----|----|----|-----|------|----|----|----|----|-----|
| | VDC (V) | 6.3 | 10 | 16 | 25 | 50 | 100 | 10 | 16 | 25 | 50 | 100 |
| 3,900pF (392) | B | B | B | B | B | B | B | I | I | I | I | I |
| 4,700pF (472) | B | B | B | B | B | B | B | I | I | I | I | I |
| 5,600pF (562) | B | B | B | B | B | B | B | I | I | I | I | I |
| 6,800pF (682) | B | B | B | B | B | B | B | I | I | I | I | I |
| 8,200pF (822) | B | B | B | B | B | B | B | I | I | I | I | I |
| 0.010μF (103) | B | B | B | B | B | B | B | I | I | I | I | I |
| 0.012μF (123) | B | B | B | B | B | B | B | I | I | I | I | I |
| 0.015μF (153) | B | B | B | B | B | B | B | I | I | I | I | I |
| 0.018μF (183) | B | B | B | B | B | B | B | I | I | I | I | I |
| 0.022μF (223) | B | B | B | B | B | B | B | I | I | I | I | I |
| 0.027μF (273) | B | B | B | B | B | B | B | I | I | I | I | I |
| 0.033μF (333) | B | B | B | B | B | B | B | I | I | I | I | I |
| 0.039μF (393) | B | B | B | B | B | B | B | I | I | I | I | I |
| 0.047μF (473) | B | B | B | B | B | B | B | I | I | I | I | I |
| 0.056μF (563) | B | B | B | B | B | B | B | I | I | I | I | I |
| 0.068μF (683) | B | B | B | B | B | B | B | I | I | I | I | I |
| 0.082μF (823) | B | B | B | B | B | B | C | I | I | I | I | I |
| 0.10μF (104) | B | B | B | B | B | B | C | I | I | I | I | I |
| 0.12μF (124) | B | B | B | B | B | B | C | I | I | I | I | I |
| 0.15μF (154) | I | I | I | I | I | I | D | I | I | I | I | C |
| 0.18μF (184) | I | I | I | I | I | I | D | I | I | I | I | C |
| 0.22μF (224) | I | I | I | I | I | I/B | D | I | I | I | I | C |
| 0.27μF (274) | I | I | I | I | I | C | D | I | I | I | I | D |
| 0.33μF (334) | I | I | I | I | I | C | D | I | I | I | C | D |
| 0.39μF (394) | I | I | I | I | J | P | D | I | I | I | C | M |
| 0.47μF (474) | J | J | J | J | J | P | D | I | I | I | C | M |
| 0.56μF (564) | J | J | J | J | J | P | P | C | C | C | C | M |
| 0.68μF (684) | J | J | J | J | J | P | P | C | C | C | C | K |
| 0.82μF (824) | J | J | J | J | J | P | P | C | C | C | C | K |

MULTILAYER CERAMIC CHIP CAPACITORS 0402 SERIES
CAPACITANCE RANGE – X7R DIELECTRIC 1206, 1210 SIZES
Table 8-H

| Size | 1206 | | | | | | 1210 | | | | | |
|-------------|---------|-----|----|----|----|----|------|----|----|----|----|-----|
| | VDC (V) | 6.3 | 10 | 16 | 25 | 50 | 100 | 10 | 16 | 25 | 50 | 100 |
| 1.0μF (105) | J | J | J | J | P | P | | C | C | C | C | K |
| 1.5μF (155) | J | J | J | P | | | | | D | D | M | M |
| 2.2μF (225) | J | J | J | P | P | P | | | D | D | M | M |
| 3.3μF (475) | P | P | P | P | | | | | D | D | M | |
| 4.7μF (475) | P | P | P | P | P | | | K | K | K | M | M |
| 10μF (106) | P | P | P | P | | | | K | K | K | M | |
| 22μF (226) | P* | P* | P* | | | | | M | M | M | | |
| 47μF (476) | | | | | | | | M | | | | |

CAPACITANCE RANGE – X7R DIELECTRIC 1812 SIZES
Table 8-I

| Size | 1812 | | | | | | |
|---------------|---------|-----|----|----|----|----|-----|
| | VDC (V) | 6.3 | 10 | 16 | 25 | 50 | 100 |
| 1,000pF (102) | C | C | C | C | C | C | C |
| 1,200pF (122) | C | C | C | C | C | C | C |
| 1,500pF (152) | C | C | C | C | C | C | C |
| 1,800pF (182) | C | C | C | C | C | C | C |
| 2,200pF (222) | C | C | C | C | C | C | C |
| 2,700pF (272) | C | C | C | C | C | C | C |
| 3,300pF (332) | C | C | C | C | C | C | C |
| 3,900pF (392) | C | C | C | C | C | C | C |
| 4,700pF (472) | C | C | C | C | C | C | C |
| 5,600pF (562) | C | C | C | C | C | C | C |
| 6,800pF (682) | C | C | C | C | C | C | C |
| 8,200pF (822) | C | C | C | C | C | C | C |
| 0.010μF (103) | C | C | C | C | C | C | C |
| 0.012μF (123) | C | C | C | C | C | C | C |
| 0.015μF (153) | C | C | C | C | C | C | C |
| 0.018μF (183) | C | C | C | C | C | C | C |

MULTILAYER CERAMIC CHIP CAPACITORS 0402 SERIES
CAPACITANCE RANGE – X7R DIELECTRIC 1812 SIZES
Table 8-J

| Size | 1812 | | | | | |
|---------------|------|----|----|----|----|-----|
| VDC (V) | 6.3 | 10 | 16 | 25 | 50 | 100 |
| 0.022μF (223) | C | C | C | C | C | C |
| 0.027μF (273) | C | C | C | C | C | C |
| 0.033μF (333) | C | C | C | C | C | C |
| 0.039μF (393) | C | C | C | C | C | C |
| 0.047μF (473) | C | C | C | C | C | C |
| 0.056μF (563) | C | C | C | C | C | C |
| 0.068μF (683) | C | C | C | C | C | C |
| 0.082μF (823) | C | C | C | C | C | C |
| 0.10μF (104) | C | C | C | C | C | C |
| 0.12μF (124) | C | C | C | C | C | C |
| 0.15μF (154) | C | C | C | C | C | C |
| 0.18μF (184) | C | C | C | C | C | C |
| 0.22μF (224) | C | C | C | C | C | C |
| 0.27μF (274) | C | C | C | C | C | C |
| 0.33μF (334) | C | C | C | C | C | C |
| 0.39μF (394) | C | C | C | C | C | C |
| 0.47μF (474) | C | C | C | C | C | K |
| 0.56μF (564) | C | C | C | C | C | K |
| 0.68μF (684) | C | C | C | C | K | K |
| 0.82μF (824) | C | C | C | C | K | K |
| 1.0μF (105) | C | C | C | C | K | K |
| 1.5μF (155) | | | | | K | K |
| 2.2μF (225) | | | | | M | M |

Note: 1) The letter in cell is expressed the symbol of product thickness. 2) The letter in cell with “ * ” mark is for “M tolerance” (20%) only

MULTILAYER CERAMIC CHIP CAPACITORS 0402 SERIES
CAPACITANCE RANGE – Y5V DIELECTRIC 0402, 0603 SIZES
Table 9-A

| Size | 0402 | | | | | 0603 | | | | | |
|---------------|---------|-----|----|----|----|------|-----|----|----|-----|-----|
| | VDC (V) | 6.3 | 10 | 16 | 25 | 50 | 6.3 | 10 | 16 | 25 | 50 |
| 0.010μF (103) | | | H | H | H | H | | S | S | S/B | S/B |
| 0.015μF (153) | | | H | H | H | H | | S | S | S | S |
| 0.022μF (223) | | | H | H | H | H | | S | S | S | S |
| 0.033μF (333) | | | H | H | H | H | | S | S | S | S |
| 0.047μF (473) | | | H | H | H | | | S | S | S | S |
| 0.068μF (683) | | | H | H | H | | | S | S | S | S |
| 0.10μF (104) | | | H | H | H | | | S | S | S/B | S/B |
| 0.15μF (154) | | | H | H | | | | S | S | S | S |
| 0.22μF (224) | H | | H | H | H | | | S | S | S | S |
| 0.33μF (334) | H | | H | H | | | | S | S | S | |
| 0.47μF (474) | H | | H | H | | | | S | S | X | |
| 0.68μF (684) | H | | | | | | | S | X | | |
| 1.0μF (105) | H | | H | | | | | S | X | | |
| 1.5μF (155) | | | | | | | | S | | | |
| 2.2μF (225) | | | | | | | S | S | | | |
| 4.7μF (475) | | | | | | | X | X | | | |

CAPACITANCE RANGE – Y5V DIELECTRIC 0805, 1206 SIZES
Table 9-B

| Size | 0805 | | | | | 1206 | | | | | |
|---------------|---------|----|----|----|----|------|----|----|----|----|-----|
| | VDC (V) | 10 | 16 | 25 | 50 | 100 | 10 | 16 | 25 | 50 | 100 |
| 0.010μF (103) | | A | A | A | A | B | B | B | B | B | B |
| 0.015μF (153) | | A | A | A | A | B | B | B | B | B | B |
| 0.022μF (223) | | A | A | A | A | B | B | B | B | B | B |
| 0.033μF (333) | | A | A | A | A | B | B | B | B | B | B |
| 0.047μF (473) | | A | A | A | A | B | B | B | B | B | B |
| 0.068μF (683) | | A | A | A | A | B | B | B | B | B | B |
| 0.10μF (104) | | A | A | A | A | B | B | B | B | B | B |
| 0.15μF (154) | | A | A | A | A | | B | B | B | B | I |
| 0.22μF (224) | | A | A | A | A | | B | B | B | B | I |
| 0.33μF (334) | | B | B | B | B | | B | B | B | B | |

MULTILAYER CERAMIC CHIP CAPACITORS 0402 SERIES
CAPACITANCE RANGE – Y5V DIELECTRIC 0805, 1206 SIZES
Table 9-C

| Size | 0805 | | | | | 1206 | | | | |
|--------------|---------|-----|----|----|----|------|----|----|----|----|
| | VDC (V) | 6.3 | 10 | 16 | 25 | 50 | 10 | 16 | 25 | 50 |
| 0.47μF (474) | | B | B | B | B | B | B | B | B | B |
| 0.68μF (684) | | B | B | C | C | C | B | B | B | B |
| 1.0μF (105) | | B | B | C | C | C | I | I | I | I |
| 1.5μF (155) | | C | C | | | | I | I | I | |
| 2.2μF (225) | | C | C | | | | I | I | I | |
| 3.3μF (335) | | C | C | | | | J | J | J | |
| 4.7μF (475) | | C | C | | | | J | J | J | |
| 6.8μF (685) | | C | | | | | J | J | | |
| 10μF (106) | C | C | C | | | | J | J | | |
| 22μF (226) | | | | | | | P | | | |

CAPACITANCE RANGE – Y5V DIELECTRIC 1210, 1812 SIZES
Table 9-D

| Size | 1210 | | | | | | 1812 | | | | | |
|---------------|---------|----|----|----|----|----|------|----|----|----|----|-----|
| | VDC (V) | 10 | 16 | 25 | 35 | 50 | 100 | 10 | 16 | 25 | 50 | 100 |
| 0.010μF (103) | | | | | | | I | | | | | C |
| 0.015μF (153) | | | | | | | I | | | | | C |
| 0.022μF (223) | | | | | | | I | | | | | C |
| 0.033μF (333) | | | | | | | I | | | | | C |
| 0.047μF (473) | | | | | | | I | | | | | C |
| 0.068μF (683) | | | | | | | I | | | | | C |
| 0.10μF (104) | I | I | I | | | I | I | C | C | C | C | C |
| 0.15μF (154) | I | I | I | | | I | I | C | C | C | C | C |
| 0.22μF (224) | I | I | I | | | I | I | C | C | C | C | C |
| 0.33μF (334) | I | I | I | | | I | I | C | C | C | C | C |
| 0.47μF (474) | I | I | I | | | I | I | C | C | C | C | C |
| 0.68μF (684) | I | I | I | | | I | I | C | C | C | C | C |
| 1.0μF (105) | I | I | I | | | I | I | C | C | C | C | C |
| 1.5μF (155) | I | I | I | | | | | C | C | C | C | |
| 2.2μF (225) | I | I | I | | | D | | C | C | C | C | |
| 3.3μF (335) | I | I | I | | | | | C | C | C | C | |

MULTILAYER CERAMIC CHIP CAPACITORS 0402 SERIES
CAPACITANCE RANGE – Y5V DIELECTRIC 1210, 1812 SIZES
Table 9-E

| Size | 1210 | | | | | 1812 | | | |
|-------------|------|----|----|----|----|------|----|----|----|
| VDC (V) | 6.3 | 10 | 16 | 25 | 50 | 10 | 16 | 25 | 50 |
| 4.7μF (475) | | I | I | C | D | C | C | C | C |
| 6.8μF (685) | | I | I | C | | C | C | C | C |
| 10μF (106) | | C | C | D | D | C | C | C | |
| 22μF (226) | | K | K | | | | | | |
| 47μF (476) | K | K | | | | | M | | |
| 100μF (107) | M | | | | | | | | |

Note: The letter in cell is expressed the symbol of product thickness.

CAPACITANCE RANGE – X5R DIELECTRIC 0201 SIZES
Table 10-A

| Size | 0201 | | | |
|---------------|------|----|----|----|
| VDC (V) | 10 | 16 | 25 | 50 |
| 100pF (101) | | L | L | L |
| 120pF (121) | | L | L | L |
| 150pF (151) | | L | L | L |
| 180pF (181) | | L | L | L |
| 220pF (221) | | L | L | L |
| 270pF (271) | | L | L | L |
| 330pF (331) | | L | L | L |
| 390pF (391) | | L | L | L |
| 470pF (471) | | L | L | L |
| 560pF (561) | | L | L | L |
| 680pF (681) | | L | L | L |
| 820pF (821) | | L | L | L |
| 1,000pF (102) | L | L | L | L |
| 1,200pF (122) | L | L | L | |
| 1,500pF (152) | L | L | L | |
| 2,200pF (222) | L | L | L | |
| 2,700pF (272) | L | L | L | |
| 3,300pF (332) | L | L | L | |
| 4,700pF (472) | L | L | L | |

MULTILAYER CERAMIC CHIP CAPACITORS 0402 SERIES
CAPACITANCE RANGE – X5R DIELECTRIC 0201 0402 SIZES
Table 10-B

| Size | 0201 | | | | | 0402 | | | | |
|---------------|------|----|----|----|----|------|----|-----|----|-----|
| | 6.3 | 10 | 16 | 25 | 50 | 6.3 | 10 | 16 | 25 | 50 |
| VDC (V) | | | | | | | | | | |
| 6,800µF (682) | | L | L | L | | | | | | |
| 0.010µF (103) | L | L | L | L | L | | | | | |
| 0.015µF (153) | L | L | | | | | | | | H |
| 0.022µF (223) | L | L | | | | | | | | H |
| 0.027µF (273) | L | L | | | | | | H | | H |
| 0.033µF (333) | L | L | | | | | | H | | H |
| 0.039µF (393) | L | L | | | | | | H | | H |
| 0.047µF (473) | L | L | | | | H | H | H | | H |
| 0.056µF (563) | L | L | | | | H | H | H | | H |
| 0.068µF (683) | L | L | | | | H | H | H | | H |
| 0.082µF (823) | L | L | | | | H | H | H | | H |
| 0.10µF (104) | L | L | L | L | | H | H | H | H | H/E |
| 0.15µF (154) | | | | | | H | H | H | H | |
| 0.22µF (224) | L | L | L* | | | H | H | H | H | H |
| 0.33µF (334) | L* | L* | | | | H | H | | | |
| 0.47µF (474) | L | | | | | H | H | H | H | H |
| 0.68µF (684) | | | | | | H | H | | | |
| 1.0µF (105) | L* | L* | L* | | | H | H | H | H | H |
| 2.2µF (225) | L* | L* | | | | H | H | H/E | H | |
| 4.7µF (475) | | | | | | H | H | H* | | |
| 10µF (106) | | | | | | H* | H* | | | |

CAPACITANCE RANGE – X5R DIELECTRIC 0603 SIZES
Table 10-C

| Size | 0603 | | | | |
|--------------|------|----|-----|----|----|
| | 6.3 | 10 | 16 | 25 | 50 |
| VDC (V) | | | | | |
| 0.22µF (224) | X | X | X | X | |
| 0.27µF (274) | | X | X | X | |
| 0.33µF (334) | X | X | X | X | |
| 0.39µF (394) | | X | X | X | |
| 0.47µF (474) | | X | X/B | X | X |

MULTILAYER CERAMIC CHIP CAPACITORS 0402 SERIES
CAPACITANCE RANGE – X5R DIELECTRIC 0603 0805 SIZES
Table 10-D

| Size | 0603 | | | | | 0805 | | | | |
|--------------|------|----|----|-----|-----|------|----|----|----|----|
| VDC (V) | 6.3 | 10 | 16 | 25 | 50 | 6.3 | 10 | 16 | 25 | 50 |
| 0.68μF (684) | X | X | X | X | | | | | | |
| 0.82μF (824) | X | X | X | X | | | | | | |
| 1.0μF (105) | X | X | X | X/B | X/B | | C | C | C | C |
| 1.5μF (155) | X | | | | | C | C | C | C | |
| 2.2μF (225) | X/B | X | X | X | X | C | C | C | C | C |
| 3.3μF (335) | X | X | | | | C | C | C | C | |
| 4.7μF (475) | X | X | X | X | | C | C | C | C | C |
| 10μF (106) | X/B | X | X | X* | | C | C | C | C | C |
| 22μF (226) | X* | X* | | | | C | C* | C* | C* | |
| 47μF (476) | | | | | | C* | C* | | | |
| 100μF (107) | | | | | | C* | | | | |

CAPACITANCE RANGE – X5R DIELECTRIC 1206, 1210 SIZES
Table 10-E

| Size | 1206 | | | | | 1210 | | | | | |
|-------------|------|----|----|-----|----|------|-----|----|----|----|----|
| VDC (V) | 6.3 | 10 | 16 | 25 | 50 | 4 | 6.3 | 10 | 16 | 25 | 50 |
| 1.5μF (155) | | J | J | | | | | K | K | | |
| 2.2μF (225) | | J | J | P | P | | | K | K | | |
| 3.3μF (335) | | P | P | P | | | | | | | |
| 4.7μF (475) | P | P | P | P | P | | | K | K | K | |
| 6.8μF (685) | P | P | | | | | | | | | |
| 10μF (106) | P | P | P | P/D | P | | K | K | K | K | M |
| 22μF (226) | P | P | P | P | | | M | M | M | | |
| 47μF (476) | P | P | P* | | | | M | M | M* | | |
| 100μF (107) | P* | | | | | | M* | M* | | | |
| 220μF (227) | | | | | | M* | M* | | | | |

Note: 1) The letter in cell is expressed the symbol of product thickness. 2) The letter in cell with “ * ” mark is for “M tolerance” (20%) only

MULTILAYER CERAMIC CHIP CAPACITORS 0402 SERIES
CAPACITANCE RANGE – X6S DIELECTRIC 0201, 0402, 0603 SIZES
Table 11-A

| Size | 0201 | | 0402 | | | | 0603 | | | | |
|--------------|------|-----|------|----|----|----|------|-----|----|----|----|
| | 4 | 6.3 | 6.3 | 10 | 16 | 25 | 4 | 6.3 | 10 | 16 | 25 |
| VDC (V) | 4 | 6.3 | 6.3 | 10 | 16 | 25 | 4 | 6.3 | 10 | 16 | 25 |
| 0.10μF (104) | L | L | | | | | | | | | |
| 0.22μF (224) | | L | | | | | | | | | |
| 0.47μF (474) | | | H | | | | | | | | |
| 1.0μF (105) | L* | | H | H | H | H | | | | | |
| 2.2μF (225) | | | H | H | H | | | | | | |
| 4.7μF (475) | | | | | | | | X | | X | X |
| 10μF (106) | | | | | | | | X* | X* | X* | |
| 22μF (226) | | | | | | | X* | X* | | | |

CAPACITANCE RANGE – X6S DIELECTRIC 0805, 1206, 1210 SIZES
Table 11-B

| Size | 0805 | | | | | | 1206 | | | | 1210 | | | |
|--------------|------|-----|----|----|----|----|------|----|----|----|------|----|----|----|
| | 4 | 6.3 | 10 | 16 | 25 | 50 | 6.3 | 10 | 16 | 25 | 6.3 | 10 | 16 | 25 |
| VDC (V) | 4 | 6.3 | 10 | 16 | 25 | 50 | 6.3 | 10 | 16 | 25 | 6.3 | 10 | 16 | 25 |
| 0.10μF (104) | | | | | | | | | | | | | | |
| 0.22μF (224) | | | | | | | | | | | | | | |
| 0.47μF (474) | | | | | | | | | | | | | | |
| 1.0μF (105) | | | | | | | | | | | | | | |
| 2.2μF (225) | | | | | | | | | | | | | | |
| 4.7μF (475) | | | | | C | C | | | | | | | | |
| 10μF (106) | C | C | C | C | C | | | | | D | | | | |
| 22μF (226) | | C* | C* | C* | | | | P | P* | | | | | M |
| 47μF (476) | C* | | | | | | P | | | | M | M | M | |
| 100μF (107) | | | | | | | | | | | M* | | | |

Note: 1) The letter in cell is expressed the symbol of product thickness. 2) The letter in cell with “ * ” mark is for “M tolerance” (20%) only

MULTILAYER CERAMIC CHIP CAPACITORS 0402 SERIES
INSULATION RESISTANCE – Requirement - Class II (X7R, X5R, X6S, Y5V)
Table 12

| Rated Voltage | IR |
|---|---|
| 100V: All X7R | 10GΩ or $RxC \geq 100 \Omega \cdot F$ whichever is smaller |
| 50V: 0402 > 0.01 μF; 0603 $\geq 1 \mu F$; 0805 $\geq 1 \mu F$; 1206 $\geq 4.7 \mu F$; 1210 $\geq 4.7 \mu F$ | |
| 35V: 0805 $\geq 2.2 \mu F$; 1206 $\geq 2.2 \mu F$; 1210 $\geq 10 \mu F$ | |
| 25V: 0402 $\geq 1 \mu F$; 0603 $\geq 2.2 \mu F$; 0805 $\geq 2.2 \mu F$; 1206 $\geq 10 \mu F$; 1210 $\geq 10 \mu F$ | |
| 16V: 0201 $\geq 0.1 \mu F$; 0402 $\geq 0.22 \mu F$; 0603 $\geq 1 \mu F$; 0805 $\geq 2.2 \mu F$; 1206 $\geq 10 \mu F$; 1210 $\geq 47 \mu F$ | |
| 10V: 0201 $\geq 47 nF$; 0402 $\geq 0.47 \mu F$; 0603 $\geq 0.47 \mu F$; 0805 $\geq 2.2 \mu F$; 1206 $\geq 4.7 \mu F$; 1210 $\geq 47 \mu F$ | |
| 6.3V; 4V; Size ≥ 1812 | |
| All X6S items | $RxC \geq 50 \Omega \cdot F.$ |
| 100V: 1210 $\geq 3.3 \mu F$ | |
| 50V: 0402 $\geq 0.1 \mu F$; 0603 $\geq 2.2 \mu F$; 0805 $\geq 10 \mu F$; 1206 $\geq 10 \mu F$ | |
| 35V: 0603 $\geq 1 \mu F$ | |
| 25V: 0201 $\geq 0.1 \mu F$; 0402 $\geq 0.22 \mu F$; 0603 $\geq 10 \mu F$; 0805 $\geq 10 \mu F$; 1206 $\geq 22 \mu F$ | |
| 16V: 0201 $\geq 0.22 \mu F$; 0402 $\geq 1 \mu F$; 0603 $\geq 10 \mu F$ | |
| 10V: 0201 > 0.1 μF; 0402 $\geq 1 \mu F$; 0603 $\geq 10 \mu F$; 0805 $\geq 47 \mu F$ | |
| 6.3V: 0201 $\geq 0.1 \mu F$; 0603 $\geq 4.7 \mu F$; 0805 $\geq 47 \mu F$; 1206 $\geq 10 \mu F$ | |
| 4V: 0603 $\geq 22 \mu F$; 0805 $\geq 47 \mu F$; 1206 $\geq 100 \mu F$ | |

TEMPERATURE COEFFICIENT- Test Condition Measurement voltage for Class II:
Table 13

| Measurement Voltage | Size |
|--|-----------|
| Cap $\leq 0.01 \mu F$: 0.5V; Cap. > 0.01 μF: 0.2V | 01005 |
| Cap < 0.1 μF: 1.0V; 0.1 μF \leq Cap. < 1.0 μF: 0.2V; Cap. $\geq 1.0 \mu F$: 0.1V (*: 0201x104/16V: 0.5V) | 0201 |
| Cap < 0.1 μF: 1.0V; Cap. = 1 μF: 0.5V; 1 μF < Cap. < 10 μF: 0.2V; Cap. $\geq 1.0 \mu F$: 0.1V | 0402 |
| Cap < 1.0 μF: 1.0V; 1.0 μF \leq Cap. $\leq 4.7 \mu F$: 0.5V; Cap. > 4.7 μF: 0.2V | 0603 |
| Cap < 10 μF: 1.0V; Cap. = 10 μF: 0.5V; Cap. > 10 μF: 0.2V | 0805 |
| Cap $\leq 10 \mu F$: 1.0V; 10 μF < Cap. $\leq 100 \mu F$: 0.5V; Cap. > 100 μF: 0.2V | 1206/1210 |

MULTILAYER CERAMIC CHIP CAPACITORS 0402 SERIES
HUMIDITY (DAMP HEAT)STEADY STATE – Requirement - Class II (X7R, X5R, X6S, Y5V)
Table 14

| Measurement Voltage | IR |
|---|--|
| 100V: X7R; 1210 \geq 3.3 μ F | 1G Ω or RxC \geq 10 Ω -F whichever is smaller |
| 50V: 0402 $>$ 0.01 μ F; 0603 \geq 1 μ F; 0805 \geq 1 μ F; 1206 \geq 4.7 μ F; 1210 \geq 4.7 μ F | |
| 35V: 0603 \geq 1 μ F; 0805 \geq 2.2 μ F; 1210 \geq 10 μ F | |
| 25V: 0201 \geq 0.1 μ F; 0402 \geq 0.22 μ F; 0603 \geq 2.2 μ F; 0805 \geq 2.2 μ F; 1206 \geq 10 μ F; 1210 \geq 10 μ F | |
| 16V: 0201 \geq 0.1 μ F; 0402 \geq 0.22 μ F; 0603 \geq 1 μ F ;0805 \geq 2.2 μ F; 1206 \geq 10 μ F; 1210 \geq 47 μ F | |
| 10V: 0201 \geq 47nF; 0402 \geq 0.47 μ F; 0603 \geq 0.47 μ F; 0805 \geq 2.2 μ F; 1206 \geq 4.7 μ F; 1210 \geq 47 μ F | |
| 6.3V; 4V; All X6S items; Size \geq 1812 | |

HIGH TEMPERATURE LOAD (ENDURANCE)– Test Condition-100% of Rated Voltage
Table 15

| Size | Dielectric | Rated Voltage | Capacitance |
|---------|-------------|----------------------|----------------------|
| 0201 | X5R/X7R/X6S | \leq 10V | C \geq 0.1 μ F |
| | | \geq 16V | C $>$ 0.1 μ F |
| 0402 | X5R | \leq 16V | C $>$ 1.0 μ F |
| | | 25V,50V | C \geq 1.0 μ F |
| | X6S | 6.3V,10V | C $>$ 1.0 μ F |
| | | 16V,25V | C \geq 1.0 μ F |
| X7R/Y5V | 6.3V,10V | C \geq 1.0 μ F | |
| 0603 | X5R/X7R/X6S | 4V | C \geq 22 μ F |
| | | 6.3V,10V | C \geq 4.7 μ F |
| | X5R/X6S | 25V | C \geq 1.0 μ F |
| | X7R | 35V | C \geq 1.0 μ F |
| 0805 | X5R/X7R/X6S | 4V | C \geq 4.7 μ F |
| | | 6.3V | C \geq 22 μ F |
| | | 10V, 50V | C \geq 10 μ F |
| | X6S/X7R | 16V, 25V | C \geq 10 μ F |
| | X5R | | C \geq 22 μ F |
| 1206 | X5R/X7R/X6S | \leq 6.3V | C \geq 47 μ F |
| 1210 | X5R/X7R/X6S | 16V | C \geq 47 μ F |
| | X7R | 100V | C \geq 3.3 μ F |

MULTILAYER CERAMIC CHIP CAPACITORS 0402 SERIES
HIGH TEMPERATURE LOAD (ENDURANCE)– Test Condition-150% of Rated Voltage
Table 16

| Dielectric | Rated Voltage | Capacitance | Dielectric |
|------------|---------------|-------------|-----------------------|
| 0201 | X5R/X6S | 16V, 25V | C= 0.1 μ F |
| | X7R | 16V | C \geq 0.00 μ F |
| 0402 | X5R/X7R/X6S | 50V | C>0.01 μ F |
| | | 10-25V | C \geq 0.22 μ F |
| | Y5V | 16V | C \geq 4.7 μ F |
| 0603 | Y7R | 50V | C>1.0 μ F |
| | | 25V | C=1.0 μ F |
| | X5R | 50V | C \geq 1.0 μ F |
| | X5R/X7R/X6S | 10V, 16V | C \geq 1.0 μ F |
| | Y5V | 16V | C \geq 2.2 μ F |
| 0805 | X5R/X7R/X6S | 100V | C \geq 0.47 μ F |
| | | 50V | C \geq 1.0 μ F |
| | | 35V | C \geq 2.2 μ F |
| | | 10-25V | C \geq 4.7 μ F |
| | Y5V | 16V | C \geq 4.7 μ F |
| 1206 | X7R | 100V | C \geq 1.0 μ F |
| | | 50V | C=4.7 μ F |
| | X5R/X6S | 100V | C>1.0 μ F |
| | | 50V | C=4.7 μ F |
| 1210 | X5R/X7R/X6S | 50-100V | C \geq 2.2 μ F |

MULTILAYER CERAMIC CHIP CAPACITORS 0402 SERIES
RELIABILITY TEST CONDITIONS AND REQUIREMENTS

| Item | Test Condition | Requirements |
|-----------------------------------|---|--|
| Visual and Mechanical | - | * No remarkable defect. * Dimensions to conform to individual spec. sheet. |
| Capacitance | Class I: (NP0) $\leq 1000\text{pF}$, $1.0 \pm 0.2\text{Vrms}$, $1\text{MHz} \pm 10\%$ $> 1000\text{pF}$, $1.0 \pm 0.2\text{Vrms}$, $1\text{KHz} \pm 10\%$ Class II: (X7R, X6S, X5R, Y5V) $C \leq 10\mu\text{F}$, $1.0 \pm 0.2\text{Vrms}$, $1\text{KHz} \pm 10\%$ ** $C > 10\mu\text{F}$, $0.5 \pm 0.2\text{Vrms}$, $120\text{Hz} \pm 20\%$ ** Test condition: $0.5 \pm 0.2\text{Vrms}$, $1\text{KHz} \pm 10\%$ X7R: 0805=106(6.3V), 0603/475(6.3V) X5R: 0201 ≥ 224 (6.3V,10V,16V)*, 0402 ≥ 475 (6.3V,16V), 0402 ≥ 225 (10V), 0603=106 (6.3V,10V)TT18X ≥ 475 (10V) , TT15X series X6S: 0201/474(4V),0201 ≥ 104 (6.3V,10V)*, 0402 ≥ 225 (6.3V), 0402/475 (10V), 0603/106 (6.3V), * Excluding X5R/0201/105(6.3V); 225(10V), X6S/0201/104(10V) ($1.0 \pm 0.2\text{Vrms}$, $1\text{KHz} \pm 10\%$) * Before initial measurement (Class II only): To apply de-aging at 150°C for 1hr for 24 ± 2 hrs at room temp. | * Shall not exceed the limits given in the detailed spec. NP0: Cap $\geq 30\text{pF}$, Q ≥ 1000 ; Cap $< 30\text{pF}$, Q $\geq 400+20\text{C}$ X7R, See <Table 3> X5R, See <Table 4> Y5V: See <Table 5> X6S: See <Table 6> |
| Q/D.F (Dissipation Factor) | | |
| Dielectric Strength | * To apply voltage ($\leq 100\text{V}$) 250%. * Duration: 1 to 5 sec. * Charge and discharge current less than 50mA. | * No evidence of damage or flash over during test. |
| Insulation Resistance | * Preconditioning for Class II MLCC: Perform a heat treatment at $150 \pm 10^\circ\text{C}$ for 1 hour, then leave in ambient condition for 24 ± 2 hours before measurement. To apply rated voltage for max. 120 sec. | Class I: (NP0) $10\text{G}\Omega$ or $\text{RxC} \geq 500\Omega\text{-F}$ whichever is smaller. Class II (X7R, X5R, X6S, Y5V) $10\text{G}\Omega$ or $\text{RxC} \geq 500\Omega\text{-F}$ whichever is smaller. See <Table 12> |

MULTILAYER CERAMIC CHIP CAPACITORS 0402 SERIES
RELIABILITY TEST CONDITIONS AND REQUIREMENTS

| Item | Test Condition | Requirements |
|---|--|--|
| Temperature Coefficient | <p>With no electrical load. @Oprating Temp. Range NP0/X7R: @ -55~125° C; X5R: -55~ 85° C ; X6S: -55~105° C ; Y5V: -25~ 85° C at 20° C</p> <p>* Before initial measurement (Class II only): To apply de-aging at 150° C for 1hr then set for 24 ± 2 hrs at room temp.</p> <ul style="list-style-type: none"> • Measurement voltage for Class II: See <Table 13> | <p>NP0: Within ±30ppm/° C X7R: Within ±15% X5R: Within ±15% X6S: Within ±22% Y5V: : Within +30%/-80%</p> |
| Adhesive Strength of Termination | <p>*Pressurizing force: 2N (0201) and 5N (≤0603) and 10N (>0603);</p> <p>* Test time: 10 ± 1 sec.</p> | <p>* No remarkable damage or removal of the terminations.</p> |
| Vibration Resistance | <p>Vibration frequency: 10~55 Hz/min.</p> <p>* Total amplitude: 1.5mm</p> <p>* Test time: 6 hrs. (Two hrs each in three mutually perpendicular directions.)</p> <p>* Before initial measurement (Class II only): To apply de-aging at 150° C for 1hr then set for 24 ± 2 hrs at room temp.</p> <p>* Cap./DF(Q) Measurement to be made after de-aging a 150° C for 1hr then set for 24 ± 2 hrs at room temp.</p> | <p>* No remarkable damage or removal of the terminations.</p> <p>* No remarkable damage.</p> <p>* Cap change and Q/D.F.: To meet initial spec.</p> |
| Bending Test | <p>* The middle part of substrate shall be pressurized by means of the pressurizing rod at a rate of about 1 mm per second until the deflection becomes 1 mm and then the pressure shall be maintained for 5 ± 1 sec.</p> <p>*Before initial measurement (Class II only): To apply de-aging at 150° C for 1hr then set for 24 ± 2 hrs at room temp.</p> <p>Measurement to be made after keeping at room temp. for 24 ± 2 hrs.</p> | <p>* No remarkable damage.</p> <p>* Cap change: NP0: within ±5% or 0.5pF whichever is larger X7R, X5R, X6S: within ±12.5% Y5V: within ±30% (This capacitance change means the change of capacitance under specified flexure of substrate from the capacitance measured before the test.)</p> |

MULTILAYER CERAMIC CHIP CAPACITORS 0402 SERIES
RELIABILITY TEST CONDITIONS AND REQUIREMENTS

| Item | Test Condition | Requirements |
|-------------------------------------|---|--|
| Resistance to Soldering Heat | <ul style="list-style-type: none"> * Solder temperature: $260 \pm 5^{\circ}$ C * Dipping time: 10 ± 1 sec * Preheating: 120 to 150° C for 1 minute before immerse the capacitor in a eutectic solder. * Before initial measurement (Class II only): To apply de-aging at 150° C for 1hr then set for 24 ± 2 hrs at room temp. * Cap. / DF(Q) / I.R. Measurement to be made after de-aging at 150° C for 1hr then set for 24 ± 2 hrs at room | <ul style="list-style-type: none"> * No remarkable damage. * Cap change: NP0: within $\pm 2.5\%$ or 0.25pF whichever is larger X7R, X5R, X6S: within $\pm 7.5\%$ Y5V: within $\pm 20\%$ * Q/D.F., I.R. and dielectric strength: To meet initial requirements. * 25% max. leaching on each edge. |
| Temperature Cycle | <ul style="list-style-type: none"> *Conduct the five cycles according to the temperatures and time. Time (min.): 30 ± 3 @ Min. operating temp.+0/-3 $^{\circ}$ C Time (min.): 2~3 @ Room temperture Time (min.): 30 ± 3 @ Max. operating temp.+3/-0 $^{\circ}$ C Time (min.): 2~3 @ Room temperture * Before initial measurement (Class II only): Perform $150+0/-10^{\circ}$ C for 1 hr and then set for 24 ± 2 hrs at room temp. * Cap. / DF(Q) / I.R. Measurement to be made after de-aging at 150° C for 1hr then set for 24 ± 2 hrs at room. | <ul style="list-style-type: none"> * No remarkable damage. * Cap change: NP0: within $\pm 2.5\%$ or 0.25pF whichever is larger X7R, X5R, X6S: within $\pm 7.5\%$ Y5V: within $\pm 20\%$ * Q/D.F., I.R. and dielectric strength: To meet initial requirements. |
| Solder ability | <ul style="list-style-type: none"> * Solder temperature: $235 \pm 5^{\circ}$ C * Dipping time: 2 ± 0.5 sec. | 95% min. coverage of all metalized area |

MULTILAYER CERAMIC CHIP CAPACITORS 0402 SERIES

RELIABILITY TEST CONDITIONS AND REQUIREMENTS

| Item | Test Condition | Requirements |
|---|---|--|
| <p>Humidity (Damp Heat) Steady State</p> | <p>* Test temp.: $40 \pm 2^\circ \text{C}$</p> <p>* Humidity: 90~95% RH</p> <p>* Test time: 500+24/-0hrs.</p> <ul style="list-style-type: none"> Before initial measurement (Class II only): Perform $150+0/-10^\circ \text{C}$ for 1 hr and then set for 24 ± 2 hrs at room temp. <p>* Cap. / DF(Q) / I.R. Measurement to be made after de-aging at 150°C for 1hr then set for 24 ± 2 hrs at room temp.</p> | <p>* No remarkable damage.</p> <p>* Cap change:</p> <p>NP0: within $\pm 5\%$ or 0.5pF whichever is larger</p> <p>X7R, X5R, X6S: $\geq 10\text{V}^{**}$, within $\pm 12.5\%$; 6.3V within $\pm 25\%$;</p> <p>** 10V: 0603 $\geq 4.7\mu\text{F}$; 0402 $\geq 1\mu\text{F}$;</p> <p>0201 $\geq 0.1\mu\text{F}$, within $\pm 25\%$;</p> <p>Y5V: $\geq 10\text{V}$, within $\pm 30\%$;</p> <p>6.3V, within $+30/\leq -40\%$</p> <p>* Q/D.F. value:</p> <p>NP0: More than 30pF $Q \geq 350$, 10pF $\leq C \leq 30\text{pF}$, $Q \geq 275+2.5C$ Less than 10pF $Q \geq 200+10C$</p> <p>X7R: See <Table 3></p> <p>X5R: See <Table 4></p> <p>Y5V: See <Table 5></p> <p>X6S: See <Table 6></p> <p>*I.R.: $\geq 10\text{V}$, 1GΩ or 50 Ω-F whichever is smaller.</p> <p>Class II (X7R, X5R, X6S, Y5V)</p> <p>See Table 14</p> |

MULTILAYER CERAMIC CHIP CAPACITORS 0402 SERIES

RELIABILITY TEST CONDITIONS AND REQUIREMENTS

| Item | Test Condition | Requirements |
|--------------------------------------|---|--|
| Humidity (Damp Heat) Load | <ul style="list-style-type: none"> *Test temp.: $40 \pm 2^\circ \text{C}$ * Humidity: 90~95%RH * Test time: 500+24/-0 hrs. * To apply voltage: rated voltage. * Before initial measurement (Class II only): To apply de-aging at 150°C for 1hr then set for 24 ± 2 hrs at room temp. * Cap. / DF(Q) / I.R. Measurement to be made after de-aging at 150°C for 1hr.then set for 24 ± 2 hrs at room temp | <ul style="list-style-type: none"> * No remarkable damage. Cap change: NP0: $\pm 7.5\%$ or 0.75pF whichever is larger. X7R, X5R, X6S: $\geq 10V^{**}$, within $\pm 12.5\%$; $\leq 6.3V$ within $\pm 25\%$; **10V: 0603 $4.7 \geq \mu\text{F}$; 0402 $\geq 1 \mu\text{F}$; 0201 $\geq 0.1 \mu\text{F}$, within $\pm 25\%$; Y5V: $\geq 10V$, within $\pm 30\%$; $\leq 6.3V$, within +30/-40% Q/D.F. value: NP0: $C \geq 30\text{pF}$, $Q \geq 200$; $C < 30\text{pF}$, $Q \geq 100+10/3C$ X7R: See <Table 3> X5R: See <Table 4> Y5V: See <Table 5> X6S: See <Table 6> * I.R.: $\geq 10V$, 500MΩ or 25 $\Omega\text{-F}$ whichever is smaller. Class II (X7R, X5R, X6S, Y5V) See Table 14 |

MULTILAYER CERAMIC CHIP CAPACITORS 0402 SERIES

RELIABILITY TEST CONDITIONS AND REQUIREMENTS

| Item | Test Condition | Requirements |
|---|--|--|
| <p>High Temperature Load (Endurance)</p> | <p>* Test temp.: NP0, X7R: $125 \pm 3^\circ \text{C}$ X6S: $105 \pm 3^\circ \text{C}$ X5R, Y5V: $85 \pm 3^\circ \text{C}$</p> <p>* Test time: 1000+24/-0 hrs.</p> <p>* To apply voltage:</p> <p>(1) $\leq 6.3\text{V}$ or $\text{C } 10 \geq \mu\text{F}$: 150% of rated voltage. (2) $10\text{V} \leq \text{Ur} < 500\text{V}$: 200% of rated voltage. (3) 500V: 150% of rated voltage. (4) $\text{Ur} \geq 630\text{V}$: 120% of rated voltage. (5) 100% of rated voltage for below range <i>See Table 15</i> (6) 150% of rated voltage for below range. <i>See Table 16</i></p> <p>* Before initial measurement (Class II only): To apply de-aging at 150°C for 1hr then set for 24 ± 2 hrs at room temp.</p> <p>* Cap. / DF(Q) / I.R. Measurement to be made after de-aging at 150°C for 1hr then set for 24 ± 2 hrs at room temp.</p> <p>** De-rating conditions:</p>  | <p>* No remarkable damage. Cap change:</p> <p>NP0: $\pm 3.0\%$ or $\pm 0.3\text{pF}$ whichever is larger</p> <p>X7R, X5R, X6S: $\geq 10\text{V}^{**}$, within $\pm 12.5\%$; $\leq 6.3\text{V}$ within $\pm 25\%$; $^{**} 10\text{V}$: $0603 \geq 4.7\mu\text{F}$; $0402 \geq 1\mu\text{F}$; $0201 \geq 0.1\mu\text{F}$, within $\pm 25\%$; Y5V: $\geq 10\text{V}$, within $\pm 30\%$; $\leq 6.3\text{V}$, within +30/-40% Q/D.F. value:</p> <p>NP0: More than 30pF, $\text{Q} \geq 350$ $10\text{pF} \leq \text{C} < 30\text{pF}$, $\text{Q} \geq 275 + 2.5\text{C}$</p> <p>Less than 10pF, $\text{Q} \geq 200 + 10\text{C}$ X7R, X5R, <i>X7R: See <Table 3></i> <i>X5R: See <Table 4></i> <i>Y5V: See <Table 5></i> <i>X6S: See <Table 6></i></p> <p>*I.R.: $\geq 10\text{V}$, $1\text{G}\Omega$ or $50\Omega\text{-F}$ whichever is smaller. Class II (X7R, X5R, X6S, Y5V) <i>See Table 14</i></p> |

MULTILAYER CERAMIC CHIP CAPACITORS 0402 SERIES

RECOMMENDED PROFILE CONDITIONS

The lead-free termination MLCCs are not only to be used on SMT against lead-free solder paste, but also suitable against lead-containing solder paste.

If the optimized solder joint is requested, increasing soldering time, temperature and concentration of N₂ within oven are recommended.

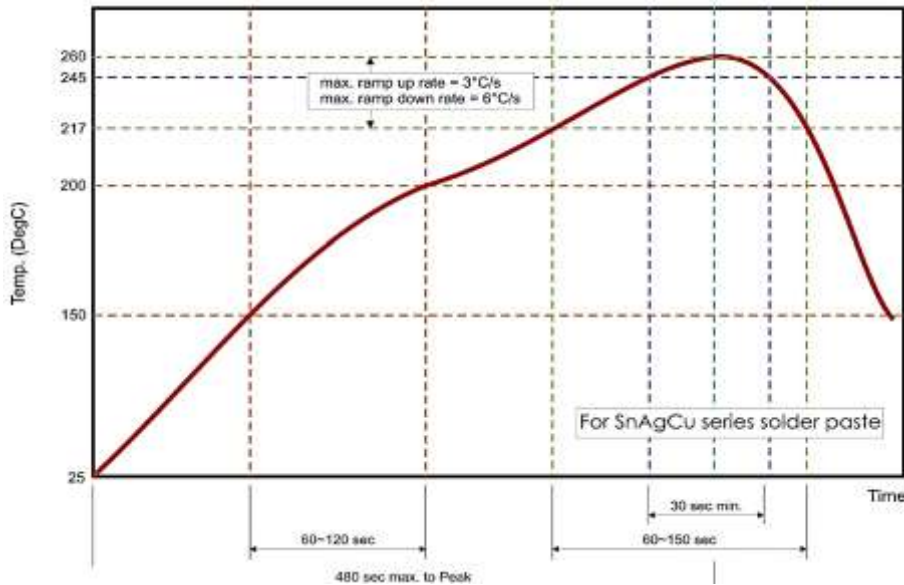

Reflow Soldering Profile For SMT Process with SnAgCu series Solder Paste



Wave Soldering Profile For SMT Process with SnAgCu series Solder Paste

MULTILAYER CERAMIC CHIP CAPACITORS 0402 SERIES
PACKAGING STYLE AND QUANTITY

| Size | Thickness (Symbol) | | Paper Tape | | Plastic Tape | |
|-------------|--------------------|---|------------|----------|--------------|----------|
| | | | 7" Reel | 13" Reel | 7" Reel | 13" Reel |
| 0201 (0603) | 0.30±0.03 | L | 15,000 | 70,000 | - | - |
| | 0.30±0.05 | L | 15,000 | | | |
| | 0.30±0.09 | L | 15,000 | | | |
| 0402 (1005) | 0.50±0.05 | H | 10,000 | 50,000 | | |
| | 0.50+0.02/-0.05 | Q | 10,000 | 50,000 | | |
| | 0.50±0.20 | E | 10,000 | | | |
| 0603 (1608) | 0.50±0.10 | N | 4,000 | | | |
| | 0.80±0.07 | S | 4,000 | 15,000 | | |
| | 0.80+0.15/-0.10 | X | 4,000 | 15,000 | | |
| 0805 (2012) | 0.50±0.10 | N | 4,000 | 15,000 | | |
| | 0.60±0.10 | A | 4,000 | 15,000 | | |
| | 0.85±0.15 | B | 4,000 | 15,000 | | |
| | 0.85±0.10 | T | 4,000 | 15,000 | | |
| | 1.25±0.15 | C | | | 3,000 | 10,000 |
| 1206 (3216) | 0.85±0.15 | B | 4,000 | 15,000 | | |
| | 0.85±0.10 | T | 4,000 | 15,000 | | |
| | 0.95±0.10 | I | | | 3,000 | 10,000 |
| | 1.15±0.15 | J | | | 3,000 | 10,000 |
| | 1.25±0.15 | C | | | 3,000 | 10,000 |
| | 1.60±0.15 | D | | | 2,000 | 10,000 |
| | 1.60+0.30/-0.10 | P | | | 2,000 | 9,000 |
| 1210 (3225) | 0.85±0.10 | T | | | 3,000 | 10,000 |
| | 0.95±0.10 | I | | | 3,000 | 10,000 |
| | 1.25±0.15 | C | | | 3,000 | 10,000 |
| | 1.60±0.15 | D | | | 2,000 | |
| | 2.00±0.20 | K | | | 1,000 | 6,000 |
| | 2.50±0.30 | M | | | 1,000 | 6,000 |

MULTILAYER CERAMIC CHIP CAPACITORS 0402 SERIES
PACKAGING STYLE AND QUANTITY

| Size | Thickness (Symbol) (mm) | | Paper Tape | | Plastic Tape | |
|-------------|----------------------------|---|-------------|--------------|--------------|--------------|
| | | | Pcs/7" Reel | pcs/13" Reel | Pcs/7" Reel | Pcs/13" Reel |
| 1812 (4532) | 1.25±0.15 | C | | | 1,000 | 5,000 |
| | 1.60±0.15 | D | | | 1,000 | |
| | 2.00±0.20 | K | | | 1,000 | |
| | 2.50±0.30 | M | | | 500 | 3,000 |
| | 2.80±0.30 | U | | | 500 | |

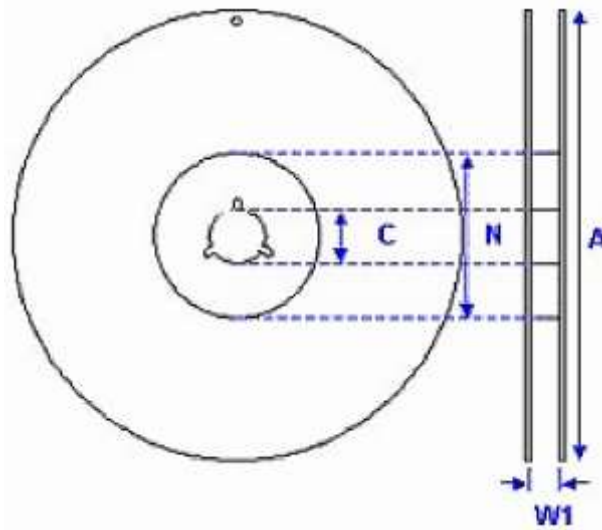
REEL DIMENSION (Unit: mm)

| Size Code | 0201, 0402, 0603, 0805, 1206, 1210 | | | 1812 |
|-----------|------------------------------------|---------------|---------------|---------------|
| Reel Size | 7" | 10" | 13" | 7" |
| C | 13.0+0.5/-0.2 | 13.0+0.5/-0.2 | 13.0+0.5/-0.2 | 13.0+0.5/-0.2 |
| W 1 | 8.4+1.5/0 | 8.4+1.5/-0 | 8.4+1.5/-0 | 12.4+2.0/-0 |
| A | 178.0±0.10 | 250.0±1.0 | 330.0±1.0 | 178.0±0.10 |
| N | 60.0+1.0/-0 | 100.0±1.0 | 100±1.0 | 60.0+1.0/-0 |

MULTILAYER CERAMIC CHIP CAPACITORS 0402 SERIES
TAPE DIMENSION (Unit: mm)

Paper Tape

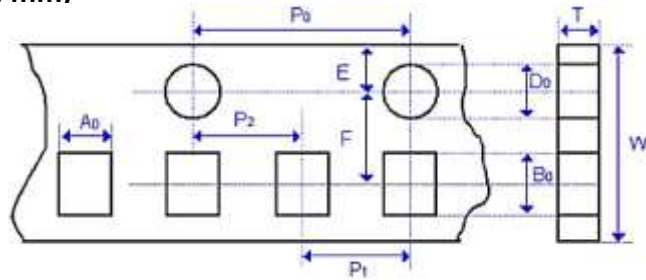

Plastic Tape

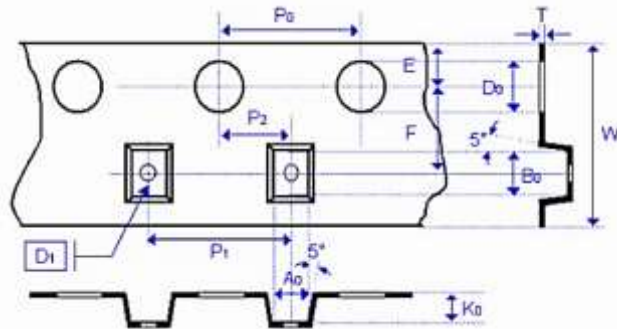

| Size | 0201 | 0402 | 0603 | 0805 | | |
|-----------|--------------|--------------|--------------|--------------|--------------|--------------|
| Thickness | L | H | H, S, B, X | A, H | B, X | C |
| A0 | 0.40 +/-0.10 | 0.70 +/-0.20 | 1.05 +/-0.30 | 1.5+/-0.20 | 1.5 +/-0.20 | < 1.80 |
| B0 | 0.70 +/-0.10 | 1.20 +/-0.20 | 1.80 +/-0.30 | 2.30 +/-0.20 | 2.30 +/-0.20 | < 2.70 |
| T | ≤0.55 | ≤0.80 | ≤1.20 | ≤1.15 | ≤1.20 | 0.23 +/-0.1 |
| K0 | - | - | - | - | - | < 2.50 |
| W | 8.00 +/-0.30 | 8.00 +/-0.30 | 8.00 +/-0.30 | 8.00 +/-0.30 | 8.00 +/-0.30 | 8.00 +/-0.30 |
| P0 | 4.00 +/-0.10 | 4.00 +/-0.10 | 4.00 +/-0.10 | 4.00 +/-0.10 | 4.00 +/-0.10 | 4.00 +/-0.10 |
| 10xP0 | 40.0 +/-0.10 | 40.0 +/-0.10 | 40.0 +/-0.20 | 40.0 +/-0.20 | 40.0 +/-0.20 | 40.0 +/-0.20 |
| P1 | 2.00 +/-0.05 | 2.00 +/-0.05 | 4.00 +/-0.10 | 4.00 +/-0.10 | 4.00 +/-0.10 | 4.00 +/-0.10 |
| P2 | 2.00 +/-0.05 | 2.00 +/-0.05 | 2.00 +/-0.05 | 2.00 +/-0.05 | 2.00 +/-0.05 | 2.00 +/-0.05 |
| D0 | 1.50 +0.1/-0 | 1.50 +0.1/-0 | 1.50 +0.1/-0 | 1.50 +0.1/-0 | 1.50 +0.1/-0 | 1.50 +0.1/-0 |
| D1 | - | - | - | - | - | 1.00 +/-0.10 |
| E | 1.75 +/-0.10 | 1.75 +/-0.10 | 1.75 +/-0.10 | 1.75 +/-0.10 | 1.75 +/-0.10 | 1.75 +/-0.10 |
| F | 3.50 +/-0.05 | 3.50 +/-0.05 | 3.50 +/-0.05 | 3.50 +/-0.05 | 3.50 +/-0.05 | 3.50 +/-0.05 |

MULTILAYER CERAMIC CHIP CAPACITORS 0402 SERIES
TAPE DIMENSION (Unit: mm)

| Size | 1206 | | | 1210 | | |
|-----------|--------------|--------------|--------------|--------------|--------------|--------------|
| | B | I, C, J | D, P | B | I, C, D, K | M |
| Thickness | | | | | | |
| A0 | 1.90 +/-0.50 | < 2.00 | < 2.30 | < 3.05 | < 3.05 | < 3.20 |
| B0 | 3.50 +/-0.50 | < 3.70 | < 4.00 | < 3.80 | < 3.80 | < 4.00 |
| T | ≤1.20 | 0.23 +/-0.1 | 0.23 +/-0.1 | 0.23 +/-0.1 | 0.23 +/-0.1 | 0.23 +/-0.1 |
| K0 | - | < 2.50 | < 2.50 | < 1.50 | < 2.50 | < 3.20 |
| W | 8.00 +/-0.30 | 8.00 +/-0.30 | 8.00 +/-0.30 | 8.00 +/-0.30 | 8.00 +/-0.30 | 8.00 +/-0.30 |
| P0 | 4.00 +/-0.10 | 4.00 +/-0.10 | 4.00 +/-0.10 | 4.00 +/-0.10 | 4.00 +/-0.10 | 4.00 +/-0.10 |
| 10xP0 | 40.0 +/-0.20 | 40.0 +/-0.20 | 40.0 +/-0.20 | 40.0 +/-0.20 | 40.0 +/-0.20 | 40.0 +/-0.20 |
| P1 | 4.00 +/-0.10 | 4.00 +/-0.10 | 4.00 +/-0.10 | 4.00 +/-0.10 | 4.00 +/-0.10 | 4.00 +/-0.10 |
| P2 | 2.00 +/-0.05 | 2.00 +/-0.05 | 2.00 +/-0.05 | 2.00 +/-0.05 | 2.00 +/-0.05 | 2.00 +/-0.05 |
| D0 | 1.50 +0.1/-0 | 1.50 +0.1/-0 | 1.50 +0.1/-0 | 1.50 +0.1/-0 | 1.50 +0.1/-0 | 1.50 +0.1/-0 |
| D1 | - | 1.00 +/-0.10 | 1.00 +/-0.10 | 1.00 +/-0.10 | 1.00 +/-0.10 | 1.00 +/-0.10 |
| E | 1.75 +/-0.10 | 1.75 +/-0.10 | 1.75 +/-0.10 | 1.75 +/-0.10 | 1.75 +/-0.10 | 1.75 +/-0.10 |
| F | 3.50 +/-0.05 | 3.50 +/-0.05 | 3.50 +/-0.05 | 3.50 +/-0.05 | 3.50 +/-0.05 | 3.50 +/-0.05 |

| Size | 1812 | |
|-----------|---------------|---------------|
| | C, D, K | M |
| Thickness | | |
| A0 | < 3.90 | < 3.90 |
| B0 | < 5.30 | < 5.30 |
| T | 0.25 +/-0.1 | 0.25 +/-0.1 |
| K0 | < 2.50 | < 3.50 |
| W | 12.00 +/-0.30 | 12.00 +/-0.30 |
| P0 | 4.00 +/-0.10 | 4.00 +/-0.10 |
| 10xP0 | 40.0 +/-0.20 | 40.0 +/-0.20 |
| P1 | 8.00 +/-0.10 | 8.00 +/-0.10 |
| P2 | 2.00 +/-0.10 | 2.00 +/-0.10 |
| D0 | 1.50 +0.1/-0 | 1.50 +0.1/-0 |
| D1 | 1.50 +/-0.10 | 1.50 +/-0.10 |
| E | 1.75 +/-0.10 | 1.75 +/-0.10 |
| F | 5.50 +/-0.10 | 5.50 +/-0.10 |

MULTILAYER CERAMIC CHIP CAPACITORS 0402 SERIES

STORAGE AND HANDLING CONDITIONS

- (1) To store products at 5 to 40°C ambient temperature and 20 to 70% related humidity conditions.
- (2) The product is recommended to be used within one year after shipment. Check solder ability in case of shelf life extension is needed.
- (3) Don't open the tape until the parts are to be used, use the chips within 3 months after the tape is opened.
- (4) For product of high dielectric constant (Class2&3, characteristics B/W & Y), the Electro static capacity changes with the passage of time due to the inherent characteristics of ceramic dielectric materials. The changed capacity reverts to nominal at the temperature it reaches during the soldering process.

CAUTIONS

- (1) The corrosive gas reacts on the terminal electrodes of capacitors, and results in the poor solder ability. Do not store the capacitors in the ambience of corrosive gas (e.g., hydrogen sulfide, sulfur dioxide, chlorine, ammonia gas etc.)
- (2) In corrosive atmosphere, solder ability might be degraded, and silver migration might occur to cause low reliability.
- (3) Due to the dewing by rapid humidity change, or the photochemical change of the terminal electrode by direct sun light, the solder ability and electrical performance may deteriorate. Do not store capacitors under direct sunlight or dewing condition. To store products on the shelf and avoid exposure to moisture.

DISCLAIMER

NextGen Component, Inc. reserves the right to make changes to the product(s) and or information contained herein without notice. No liability is assumed as a result of their use or application. No rights under any patent accompany the sale of any such product(s) or information