



SPECIFICATION SHEET

SPECIFICATION SHEET NO.	Q0608- CRRCR02FC62KS1
DATE	June. 8, 2023
REVISION	A0
DESCRIPTION	General purpose Chip Resistors, 0402 (1005 Metric), RCR02 Series, Dimension L1.00*W0.50*H0.35mm, 2 Terminations, Tolerance: ±1.0%, Resistance 62K ohm, Dissipation Max. 1/16W @ 70°C, Temperature Coefficient Rate (TCR) Max. ±100ppm/°C Operating Temp. Range -55°C ~+155°C Package in Tape/Reel, 10,000pcs/Reel RoHS/RoHS III compliant and HF
CUSTOMER	
CUSTOMER PART NUMBER	
CROSS REF. PART NUMBER	
ORIGINAL PART NUMBER	Aillen RCR02FC62K
PART CODE	CRRCR02FC62KS1

VENDOR APPROVE			
Issued/Checked/Approved			
DATE: June. 8, 2023			

CUSTOMER APPROVE	
DATE:	

6/8/2023

GENERAL PURPOSE CHIP RESISTORS RCR02 SERIES

DESCRIPTION

The LEAD FREE resistors are constructed in a high grade ceramic body (aluminum oxide). Internal metal electrodes are added at each end and connected by a LEAD FREE resistive paste that is applied to the top surface of the substrate. The composition of the paste is adjusted to give the approximate resistance required and the value is trimmed to nominated value within tolerance which controlled by laser trimming of this resistive layer. The resistive layer is covered with a BLACK protective coat. Finally, the two external end terminations are added. For ease of soldering the outer layer of these end terminations is a Tin (LEAD FREE) alloy.



MAIN FEATURE

- High reliability and stability
- Reduced size of final equipment
- Lower assembly costs
- Higher component and equipment reliability
- RoHS exemption free and Lead free products

APPLICATION

- Consumer electrical equipment
- Automotive application
- EDP, Computer application
- Telecom application

RFQ

[Request For Quotation](#)

PART CODE GUIDE

CRRCR	02	F	C	62K	S1
1	2	3	4	5	6

1) **CRRCR**: Product code for General purpose Chip Resistors

2) **02**: Size Code, 0402 (1005 Metric), RCR02 Series, Dimension L1.00*W0.50*H0.35mm,

3) **F**: Resistance Range Tolerance Code, P: Jumper; B: +/-0.1%; D: +/-0.5%; F: +/-1%; J: +/-5%

4) **C**: Package Code, A: 4Kpcs/7"Reel; B:5kpcs/7"Reel; C:10kpcs/7"Reel; M:15kpcs/7"Reel; D:10kpcs/10"Reel; E:20kpcs/10"Reel,

5) **62K**: Resistance value code. 0R: 0ohm; R56: 0.56ohm; 15R: 15ohm; 20R: 20ohm; 22R1: 22.1ohm; 51R: 51ohm; 100R: 100ohm;

750R: 750ohm; 1K:1Kohm; 1K87: 1.87Kohm; 4K7: 4.7Kohm; 10K: 10Kohm; 10K5: 10.5Kohm; 62K: 62 Kohm; 100K: 100Kohm; 820K:

820Kohm; 1M: 1.0Mohm; 1M2: 1.2Mohm

6) **S1**: Internal control code, digits and letter; Blank: N/A

6/8/2023

GENERAL PURPOSE CHIP RESISTORS RCR02 SERIES

DIMENSION (Unit: mm)

Image for reference



General Marking:

RCR02 has no marking.

RCR02 series

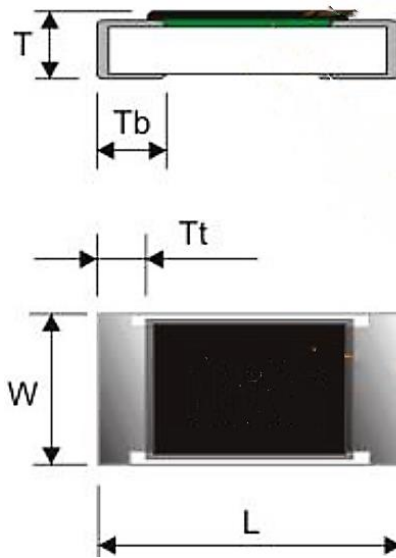

Item	Dimension
L	1.00±0.05
W	0.50±0.05
T	0.35±0.05
T b	0.25±0.10
T t	0.20±0.10

Resistors Construction For Reference

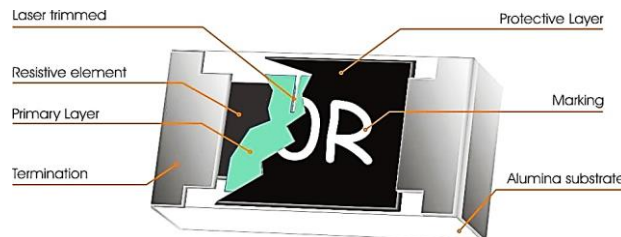

GENERAL PURPOSE CHIP RESISTORS RCR02 SERIES
GENERAL ELECTRONICAL CHARACTERISTICS

Item	Unit	Symbol	Characteristic	Condition
Product Name		CRRCR	General purpose Chip Resistors	
Size		02	RCR02 Series, L1.00*W0.50*H0.35mm	
Resistance Range	Ω		62K	
Resistance Tolerance	%	F	+/-1	
TCR	R≥1MΩ	ppm/°C	≤±300	Resistance Tolerance:±1%
	1MΩ > R > 10Ω		≤±100	
	R≤10Ω		-300~+500	
TCR	R≥1MΩ	ppm/°C	≤±300	Resistance Tolerance:±5%
	1MΩ > R > 10Ω		≤±200	
	R≤10Ω		-300~+500	
Max. Dissipation	W		1/16	@ Tamb=70°C
Operating Temperature	°C		-55 ~+155	
Max. Operation Voltage	V		50	@DC or RMS
Max. Overload Voltage	V		100	@DC or RMS

Note

- 1) This is the maximum voltage that may be continuously supplied to the resistor element, see "IEC publication 60115-8"
- 2) Max. Operation Voltage : So called RCWV (Rated Continuous Working Voltage) is determined by

$$RCWV = \sqrt{\text{Rated Power} \times \text{Resistance Value}}$$
or Max. RCWV listed above, whichever is lower.
- 3) The resistance of Jumper is defined as max. 0.05Ω, Test condition for jumper (0 Ω)

Item	Unit	Symbol	Characteristic	Condition
Power Rating At 70°C	W		1/16	
Max. Resistance	mΩ		50	
Rated Current	A		1.0	
Peak Current	A		1.5	
Operating Temperature	°C		-55 ~+155	

GENERAL PURPOSE CHIP RESISTORS RCR02 SERIES

PRODUCT CHARACTERIZATION

Standard values of nominal resistance are taken from the E24 & E96 series for resistors with a tolerance of $\pm 0.1\%$, $\pm 0.5\%$, $\pm 1\%$ & $\pm 5\%$. The values of the E24/E96 series are in accordance with "IEC publication 60063"

DERATING

The power that the resistor can dissipate depends on the operating temperature; see Fig.1

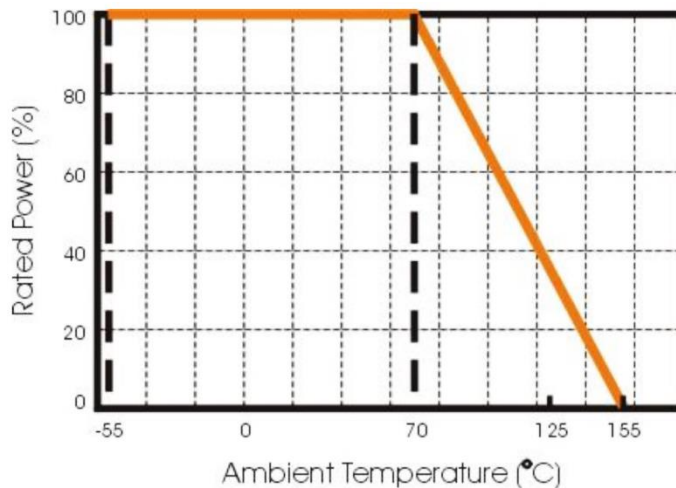

Fig 1 Maximum dissipation in percentage of rated power as a function of the ambient temperature for RCR02

MOUNTING

Due to their rectangular shapes and small tolerances, Surface Mountable Resistors are suitable for handling by automatic placement systems. Chip placement can be on ceramic substrates and printed-circuit boards (PCBs). Electrical connection to the circuit is by individual soldering condition. The end terminations guarantee a reliable contact.

GENERAL PURPOSE CHIP RESISTORS RCR02 SERIES

REFLOW SOLDERING CONDITION

The robust construction of chip resistors allows them to be completely immersed in a solder bath of 260 °C for 10 seconds. Therefore, it is possible to mount Surface Mount Resistors on one side of a PCB and other discrete components on the reverse (mixed PCBs). Surface Mount Resistors are tested for solderability at 235 °C during 2 seconds. The test condition for no leaching is 260°C for 30 seconds. Typical examples of soldering processes that provide reliable joints without any damage are given in below.

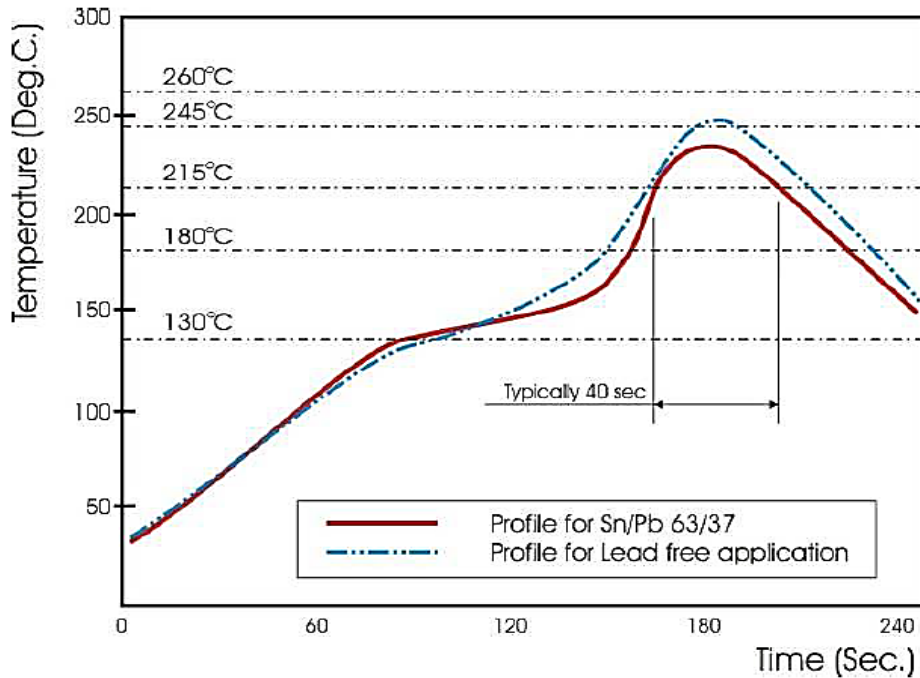

Fig 2. Infrared soldering profile for Chip Resistors

LEAD content: below 100ppm with reference to IEC62321, determination of LEAD by ICP-AES

GENERAL PURPOSE CHIP RESISTORS RCR02
TEST AND REQUIREMENT (JIS C 5201-1 : 1998)

TEST	PROCEDURE / TEST METHOD	REQUIREMENT	
		Resistor	0Ω
DC resistance Clause 4.5	DC resistance values measured at the test voltages specified below : <10Ω@0.1V, <100Ω@0.3V, <1KΩ@1.0V, <10KΩ@3V, <100KΩ@10V, <1MΩ@25V, <10MΩ@30V	Within the specified tolerance	<50mΩ
Temperature Coefficient of Resistance(T.C.R) Clause 4.8	Natural resistance change per change in degree centigrade. $\frac{R_2 - R_1}{R_1(t_2 - t_1)} \times 10^6 \text{ (ppm/}^\circ\text{C)}$ t1 : 20°C+5°C-1°C R1 : Resistance at reference temperature R2: Resistance at test temperature	Refer to “QUICK REFERENCE DATA”	N/a
Short time overload (S.T.O.L) Clause 4.13	Permanent resistance change after a 5second application of a voltage 2.5 times RCWV or the maximum overload voltage specified in the above list, whichever is less.	1% tol.:Δ R/R max. ±(1%+0.10Ω) 5% tol.:Δ R/R max. ±(2%+0.10Ω)	<50mΩ
Resistance to soldering heat(R.S.H) Clause 4.18	Un-mounted chips completely immersed for 10±1second in a SAC solder bath at 260C±5°C	1% tol.:Δ R/R max. ±(0.5%+0.10Ω) 5% tol.:Δ R/R max. ±(1%+0.10Ω)	<50mΩ
Solderability Clause 4.17	Un-mounted chips completely immersed for 2±0.5second in a SAC solder bath at 235C±5C	95% coverage min., good tinning and no visible damage	
Temperature cycling Clause 4.19	30 minutes at -55°C±3°C, 2~3 minutes at 20°C+5°C-1°C, 30 minutes at +155°C±3°C, 2~3 minutes at 20°C+5°C-1°C, total 5 continuous cycles	1% tol.:Δ R/R max. ±(0.5%+0.10Ω) 5% tol.:Δ R/R max. ±(1%+0.10Ω)	<50mΩ
Damp Heat (Load life in humidity) Clause 4.24	1000 +48/-0 hours, loaded with RCWV or Vmax in humidity chamber controller at 40°C±2°C and 90~95% relative humidity.	1% tol.:Δ R/R max. ±(1%+0.10Ω) 5% tol.:Δ R/R max. ±(2%+0.10Ω)	<50mΩ

GENERAL PURPOSE CHIP RESISTORS RCR02

TEST AND REQUIREMENT (JIS C 5201-1 : 1998)

TEST	PROCEDURE / TEST METHOD	REQUIREMENT	
		Resistor	0Ω
Load Life (Endurance) Clause 4.25	1000+48/-0 hours; loaded with RCWV or Vmax in chamber controller 70±2°C, 1.5 hours on and 0.5 hours off	1% tol.: ΔR/R max. ±(1%+0.10Ω) 5% tol.: ΔR/R max. ±(2%+0.10Ω)	<50mΩ
Bending strength Clause 4.33	Resistors mounted on a 90mm glass epoxy resin PCB(FR4), bending once 3mm for 10sec, 5mm for WR04	1% tol.: ΔR/R max. ±(0.5%+0.10Ω) 5% tol.: ΔR/R max. ±(1%+0.10Ω)	<50mΩ
Adhesion Clause 4.32	Pressurizing force: 5N, Test time: 10±1sec.	No remarkable damage or removal of the terminations	

GENERAL PURPOSE CHIP RESISTORS RCR02 SERIES

REEL DIMENSION (Unit: mm)

7": 10,000pcs/Reel

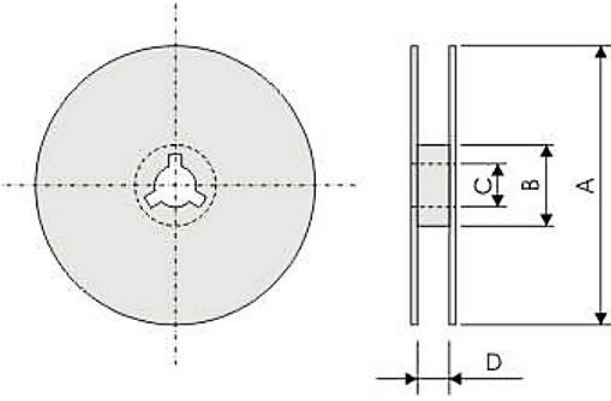

Code	Dimension 7"
A	178+/-2.0
B	60.0 +/-1.0
C	13.0+/-0.20
D	9.0+/-0.5

TAPE DIMENSION (Unit: mm)

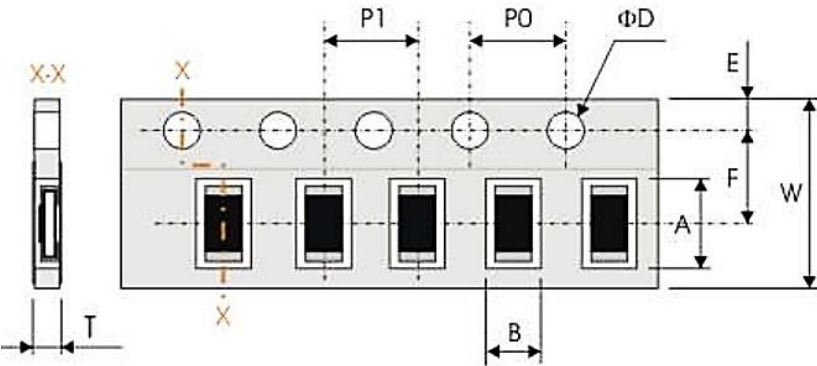

Code	Dimension
A	1.20±0.10
B	0.70±0.10
W	8.00±0.30
F	3.50±0.20
E	1.75±0.10
P 1	2.00±0.10
P0	4.00±0.10
ΦD	1.50±0.10
T	0.40±0.05

TAPING QUANTITY AND TAPE MATERIAL

Tape	Paper Tape						Embossed Tape	Bulk Cassette
	4 mm Pitch			2 mm Pitch			4 mm Pitch	
Reel Size	7"	10"	13"	7"	10"	13"	7"	
RCR02	-	-	-	10000	-	-	-	10000

GENERAL PURPOSE CHIP RESISTORS RCR02 SERIES

PERFORMANCE OF TAPING

Strength of Carrier Tape and Top Cover Tape

Carrier Tape: When a tensile force 1.02kgf is applied in the direction of unreeling the tape, the tape shall withstand this force. Top cover Tape: When a tensile force 1.02kgf is applied to the tape, the tape shall withstand this force.

Peel Force of Top Cover Tape

Unless otherwise specified, the peel force of top cover tape shall be 10.2 to 71.4 g f when the top cover tape is pulled at a speed of 300mm/min with the angle between the taped during peel and the direction of unreeling maintained at 165 to 180° as illustrated in Fig.



DISCLAIMER

NextGen Component, Inc. reserves the right to make changes to the product(s) and or information contained herein without notice. No liability is assumed as a result of their use or application. No rights under any patent accompany the sale of any such product(s) or information