

SPECIFICATION SHEET

SPECIFICATION SHEET NO.	Q0608- CRCROEFF100KS1
DATE	June. 8, 2023
REVISION	A0
DESCRIPTION	Thick Film Chip Resistors, 01005 (0402 Metric), CROE Series, Dimension L0.40*W0.20*H0.13mm, 2 Terminations, Tolerance: ±1.0%, Resistance 100K ohm, Dissipation Max. 1/32W @ 70°C, Temperature Coefficient Rate (TCR) Max. ±200ppm/°C Operating Temp. Range -55°C ~+125°C Package in Tape/Reel, 20,000pcs/Reel RoHS/RoHS III compliant and HF
CUSTOMER	
CUSTOMER PART NUMBER	
CROSS REF. PART NUMBER	
ORIGINAL PART NUMBER	Aillen CROEFF100K
PART CODE	CRCROEFF100KS1

VENDOR APPROVE

Issued/Checked/Approved



DATE: June. 8, 2023

CUSTOMER APPROVE

DATE:

6/8/2023

THICK FILM CHIP RESISTORS CROE SERIES

DESCRIPTION

The resistors are constructed in a high grade ceramic body (aluminum oxide). Internal metal electrodes are added at each end and connected by a resistive paste that is applied to the top surface of the substrate. The composition of the paste is adjusted to give the approximate resistance required and the value is trimmed to within tolerance by laser cutting of this resistive layer. The resistive layer is covered with a protective coat. Finally, the two external end terminations are added. For ease of soldering the outer layer of these end terminations is a pure Tin.



MAIN FEATURE

- Ultra small and high precision size and light weight
- High reliability and stability
- Reduced size of final equipment
- Suitable for high density print circuit board assembly
- Higher component and equipment reliability
- Lead free product

APPLICATION

- Mobile phone
- PDA, MP3, Ipod, iPhone
- DSC, DVs, Mini module
- Palmtop computers

PART CODE GUIDE

RFQ

[Request For Quotation](#)

CRCR	OE	F	F	100K	S1
1	2	3	4	5	6

1) **CRCR**: Product code for Thick Film Chip Resistors

2) **OE**: Size Code, 01005 (0402 Metric), CROESeries, Dimension L0.40*W0.20*H0.13mm,

3) **F**: Resistance Range Tolerance Code, P: Jumper; B: +/-0.1%; D: +/-0.5%; F: +/-1%; J: +/-5%

4) **F**: Package Code, A: 4Kpcs/7"Reel; B:5kpcs/7"Reel; C:10kpcs/7"Reel; M:15kpcs/7"Reel; D:10kpcs/10"Reel; E:20kpcs/10"Reel, F:20kpcs/7"Reel

5) **100K**: Resistance value code. 0R: 0ohm; R56: 0.56ohm; 15R: 15ohm; 20R: 20ohm; 22R1: 22.1ohm; 51R: 51ohm; 100R: 100ohm; 750R: 750ohm; 1K:1Kohm; 1K87: 1.87Kohm; 4K7: 4.7Kohm; 10K: 10Kohm; 10K5: 10.5Kohm; 39K: 39 Kohm; 100K: 100Kohm; 820K: 820Kohm; 1M: 1.0Mohm; 1M2: 1.2Mohm

6) **S1**: Internal control code, digits and letter; Blank: N/A

THICK FILM CHIP RESISTORS CROE SERIES

DIMENSION (Unit: mm)

Image for reference



General Marking:
CROE has no marking.

CROE series

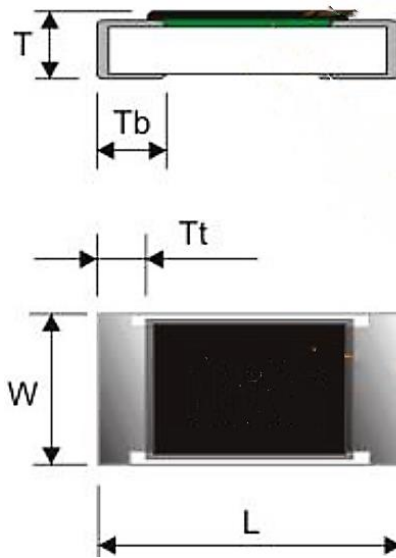

Item	Dimension
L	0.40±0.02
W	0.20±0.02
T	0.13±0.02
T b	0.10±0.03
T t	0.08±0.03

Resistors Construction For Reference

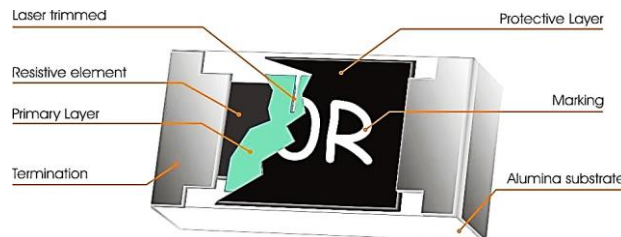

THICK FILM CHIP RESISTORS CROE SERIES
GENERAL ELECTRONICAL CHARACTERISTICS

Item		Unit	Symbol	Characteristic	Condition
Product Name			CRCR	Thick Film Chip Resistors	
Size			OE	CROESeries, L0.40*W0.20*H0.13	
Resistance Range		Ω		100K	
Resistance Tolerance		%	F	+/-1	
TCR	100Ω - 1M	ppm/°C		≤±200	
	10Ω- 91Ω			≤±300	
	4.7 - 9.1Ω			+600~ -200ppm	
Max. Dissipation		W		1/32	@ Tamb=70°C
Operating Temperature		°C		-55 ~+125	
Max. Operation Voltage		V		15	@DC or RMS
Max. Overload Voltage		V		30	@DC or RMS

Note

- 1) This is the maximum voltage that may be continuously supplied to the resistor element, see "IEC publication 60115-8"
- 2) Max. Operation Voltage : So called RCWV (Rated Continuous Working Voltage) is determined by

$$RCWV = \sqrt{\text{Rated Power} \times \text{Resistance Value}} \text{ or Max. RCWV listed above, whichever is lower.}$$

THICK FILM CHIP RESISTORS CROE SERIES

PRODUCT CHARACTERIZATION

Standard values of nominal resistance are taken from the E24 & E96 series for resistors with a tolerance of +/-0.1%, +/-0.5%, +/-1% & +/-5%, The values of the E24/E96 series are in accordance with "IEC publication 60063"

DERATING

The power that the resistor can dissipate depends on the operating temperature; see Fig.1

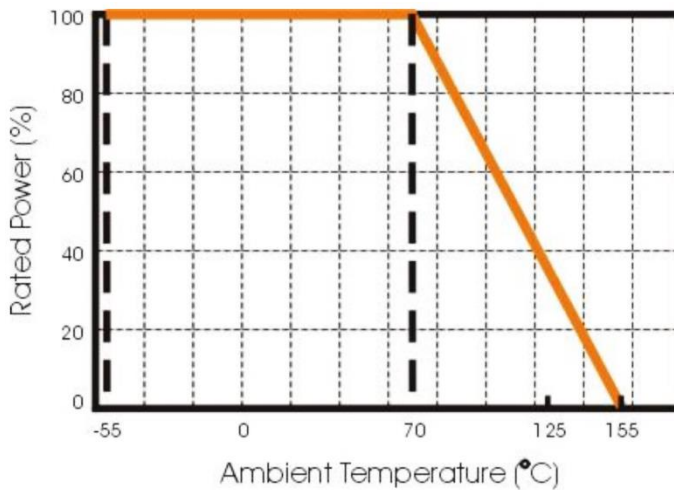
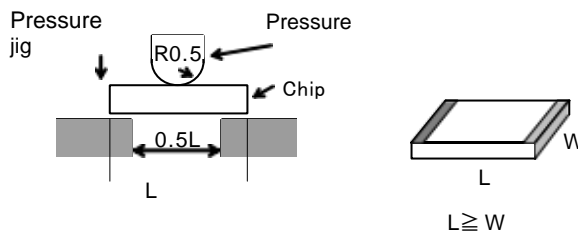

Fig 1 Maximum dissipation in percentage of rated power as a function of the ambient temperature for CROE

MOUNTING

Due to its rectangular shape and ultra small size, Surface Mountable Resistors 01005 should be carefully handling by automatic placement systems. 01005 chip can withstand pressure force min. 1.9N by applying $\phi 0.18$ pressure jig as shown drawing below. For mounting application, Please contact us



THICK FILM CHIP RESISTORS CROE SERIES

REFLOW SOLDERING CONDITION

The robust construction of chip resistors allows them to be completely immersed in a solder bath of 260 °C for 10 seconds. Therefore, it is possible to mount Surface Mount Resistors on one side of a PCB and other discrete components on the reverse (mixed PCBs). Surface Mount Resistors are tested for solderability at 235 °C during 2 seconds. The test condition for no leaching is 260°C for 30 seconds. Typical examples of soldering processes that provide reliable joints without any damage are given in below.

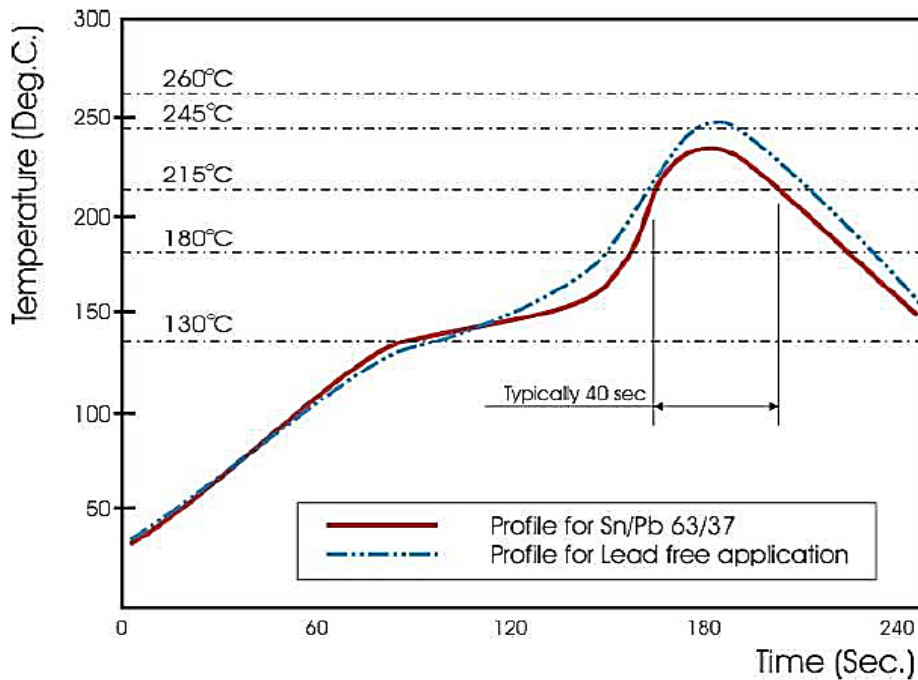

Fig 2. Infrared soldering profile for Chip Resistors

THICK FILM CHIP RESISTORS CROE SERIES
TEST AND REQUIREMENT (JIS C 5201-1 : 1998)

TEST	PROCEDURE / TEST METHOD	REQUIREMENT	
		Resistor	Ω
DC resistance Clause 4.5	DC resistance values measured at the test voltages specified below : <10Ω@0.1V, <100Ω@0.3V, <1KΩ@1.0V, <10KΩ@3V, <100KΩ@10V, <1MΩ@25V, <10MΩ@30V	Within the specified tolerance	<50mΩ
Temperature Coefficient of Resistance(T.C.R) Clause 4.8	Natural resistance change per change in degree centigrade. $\frac{R_2 - R_1}{R_1(t_2 - t_1)} \times 10^6 \text{ (ppm/}^\circ\text{C)}$ t1 : 20°C+5°C-1°C R1 : Resistance at reference temperature R2: Resistance at test temperature	Refer to “QUICK REFERENCE DATA”	N/a
Short time overload (S.T.O.L) Clause 4.13	Permanent resistance change after a 5second application of a voltage 2.5 times RCWV or the maximum overload voltage specified in the above list, whichever is less.	Δ R/R max. ±(1%+0.05Ω)	<50mΩ
Resistance to soldering heat(R.S.H) IEC 60068-2-58: 2004	Un-mounted chips completely immersed for 10±0.5second in a SAC solder bath at 260C±5°C	Δ R/R max. ±(1%+0.05Ω) No visible damage	<50mΩ
Solderability IEC 60068-2-58: 2004	Un-mounted chips completely immersed for 2±0.3second in a SAC solder bath at 235C±5C	95% coverage min., good tinning and no visible damage	
Temperature cycling Clause 4.19	30 minutes at -55°C±3°C, 2~3 minutes at 20°C+5°C-1°C, 30 minutes at +125°C±3°C, 2~3 minutes at 20°C+5°C-1°C, total 5 continuous cycles	ΔR/R max. ±(1%+0.05Ω)	<50mΩ
Damp Heat (Load life in humidity) Clause 4.24	1000 +48/-0 hours, loaded with RCWV or Vmax in humidity chamber controller at 40°C±2°C and 90~95% relative humidity.	ΔR/R max. ±(5%+0.10Ω) no visible damage	<50mΩ

THICK FILM CHIP RESISTORS CROE SERIES

TEST AND REQUIREMENT (JIS C 5201-1 : 1998)

TEST	PROCEDURE / TEST METHOD	REQUIREMENT	
		Resistor	0Ω
Load Life (Endurance) Clause 4.25	1000+48/-0 hours; loaded with RCWV or Vmax in chamber controller 70±2°C, 1.5 hours on and 0.5 hours off	Δ R/R max. ±(5%+0.10Ω) No visible damage	<50mΩ
Endurance at the upper category temperature	125°C, no load, 1000 hours	Δ R/R max. ±(5%+0.10Ω) No visible damage	<50mΩ
Bending strength Clause 4.33	Resistors mounted on a 90mm glass epoxy resin PCB(FR4); bending : 3 mm, once for 10 seconds.	Δ R/R max. ±(1%+0.05Ω) No visible damage	<50mΩ
Adhesion Clause 4.32	Pressurizing force: 2N, Test time: 10±1sec.	No visible damage	

THICK FILM CHIP RESISTORS CROE SERIES
REEL DIMENSION (Unit: mm)

7": 20,000pcs/Reel

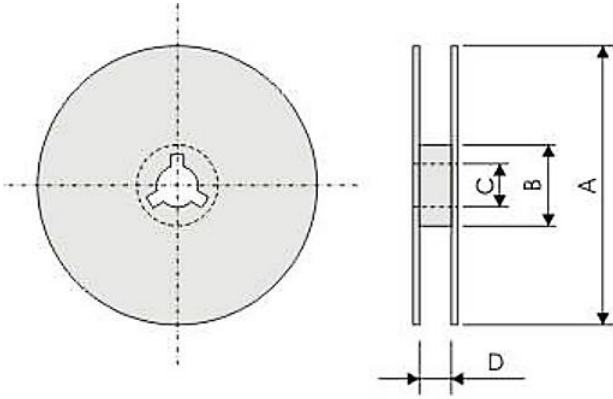

Code	Dimension 7"
A	180.0+/-1.5
B	60.0 +/-1.0
C	13.0+/-0.20
D	Paper tape: 9.0+1/-0 Emboss tape: 4.2±0.8

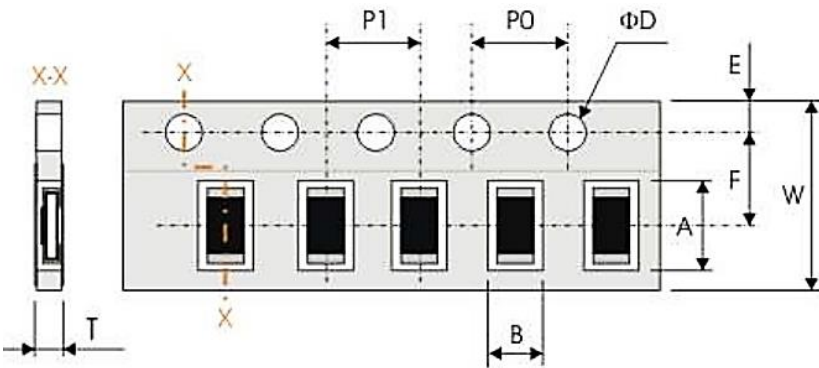
TAPE DIMENSION (Unit: mm)

Code	Dimension
A	0.45±0.03
B	0.24±0.03
W	8.00±0.20
F	3.50±0.05
E	1.75±0.10
P 1	2.00±0.05
P0	4.00±0.05
ΦD	1.50±0.10
T	0.36±0.03

TAPING QUANTITY AND TAPE MATERIAL

Tape	Paper Tape						Embossed Tape	Bulk Cassette
	4 mm Pitch			2 mm Pitch			4 mm Pitch	
Reel Size	7"	10"	13"	7"	10"	13"	7"	
CROE	-	-	-	20000	-	-	35000	-

THICK FILM CHIP RESISTORS CROE SERIES

PERFORMANCE OF TAPING

Strength of Carrier Tape and Top Cover Tape

Carrier Tape: When a tensile force 1.02kgf is applied in the direction of unreeling the tape, the tape shall withstand this force. Top cover Tape: When a tensile force 1.02kgf is applied to the tape, the tape shall withstand this force.

Peel Force of Top Cover Tape

Unless otherwise specified, the peel force of top cover tape shall be 10.2 to 71.4 g f when the top cover tape is pulled at a speed of 300mm/min with the angle between the taped during peel and the direction of unreeling maintained at 165 to 180° as illustrated in Fig.

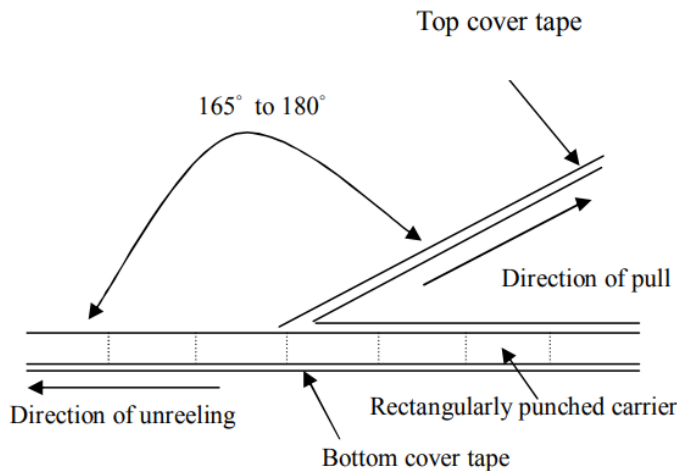

DISCLAIMER

NextGen Component, Inc. reserves the right to make changes to the product(s) and or information contained herein without notice. No liability is assumed as a result of their use or application. No rights under any patent accompany the sale of any such product(s) or information