



SPECIFICATION SHEET

SPECIFICATION SHEET NO.	Q0606- CRCP12JA68KS01
DATE	June. 6, 2023
REVISION	A0
DESCRIPTION	High power Chip Resistors, 2512 (6432 Metric), CP12 Series, Dimension L6.30*W3.10*H0.60mm, 2 Terminations, Tolerance: ±5.0%, Resistance 68K ohm, Dissipation Max. 2W @ 70°C, Temperature Coefficient Rate (TCR) Max. ±100ppm/°C Operating Temp. Range -55°C ~+155°C Package in Tape/Reel, 4,000pcs/Reel RoHS/RoHS III compliant and HF
CUSTOMER	
CUSTOMER PART NUMBER	
CROSS REF. PART NUMBER	
ORIGINAL PART NUMBER	Aillen CP12JA68K
PART CODE	CRCP12JA68KS01

VENDOR APPROVE			
Issued/Checked/Approved			
DATE: June. 6, 2023			

CUSTOMER APPROVE	
DATE:	

6/6/2023

HIGH POWER CHIP RESISTORS CP12 SERIES

DESCRIPTION

The resistors are constructed in a high grade ceramic body (aluminum oxide). Internal metal electrodes are added at each end and connected by a resistive paste that is applied to the top surface of the substrate. The composition of the paste is adjusted to give the approximate resistance required and the value is trimmed to within tolerance by laser cutting of this resistive layer. The resistive layer is covered with a protective coat. Finally, the two external end terminations are added. For ease of soldering the outer layer of these end terminations is a Tin (lead free) alloy.



MAIN FEATURE

- High power rating and compact size
- High reliability and stability
- Reduced size of final equipment
- RoHS compliant and Lead free products
- Flame Retardant

APPLICATION

- Power supply / PDA
- Digital meter / PC
- Automotives / Battery charger
- DC-DC power converter

PART CODE GUIDE

RFQ

[Request For Quotation](#)

CRCP	12	J	A	68K	S01
1	2	3	4	5	6

- 1) **CRCP**: Product code for High power Chip Resistors
- 2) **12**: Size Code, 2512 (6432 Metric), CP12 Series, Dimension L6.30*W3.10*H0.60mm,
- 3) **J**: Resistance Range Tolerance Code, P: Jumper; B: +/-0.1%; D: +/-0.5%; F: +/-1%; J: +/-5%
- 4) **A**: Package Code, A: 4Kpcs/7"Reel; B:5kpcs/7"Reel; C:10kpcs/7"Reel; M:15kpcs/7"Reel; D:10kpcs/10"Reel; E:20kpcs/10"Reel
- 5) **68K**: Resistance value code. 0R: 0ohm; R56: 0.56ohm; 15R: 15ohm; 20R: 20ohm; 22R1: 22.1ohm; 33R: 33ohm; 100R: 100ohm; 750R: 750ohm; 1K:1Kohm; 1K87: 1.87Kohm; 4K7: 4.7Kohm; 10K: 10Kohm; 10K5: 10.5Kohm; 68K: 68 Kohm; 150K: 150Kohm; 226K: 226Kohm; 1M: 1.0Mohm; 1M2: 1.2Mohm
- 6) **S01**: Internal control code, digits and letter; Blank: N/A

HIGH POWER CHIP RESISTORS CP12 SERIES

DIMENSION (Unit: mm)

Image for reference

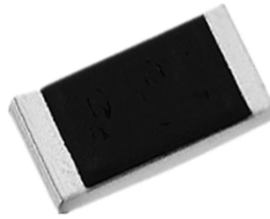

General Marking:

3-digits marking

*Each resistor is marked with a three digits code on the protective coating to designate the nominal resistance value

CP12 series

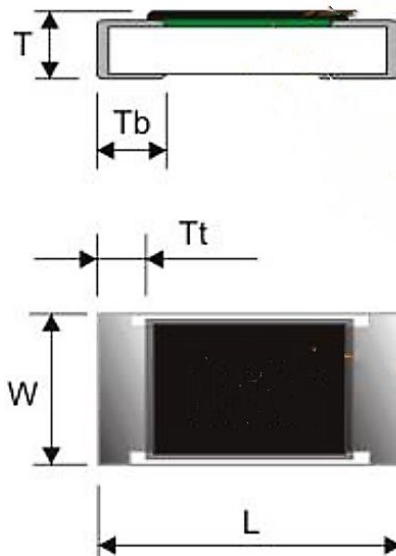

Item	Dimension
L	6.30±0.20
W	3.10±0.20
T	0.60±0.15
T b	0.90±0.25
T t	0.60±0.25

Resistors Construction For Reference

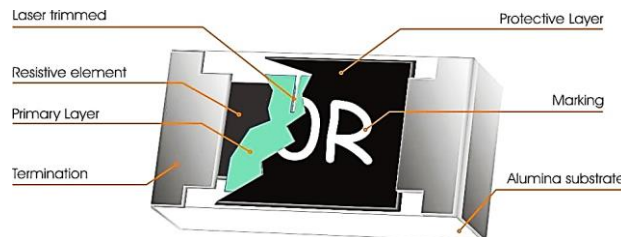

Recommended Solder Pad

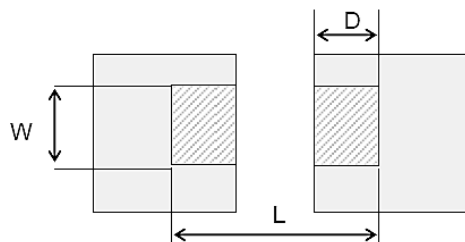

Item	Dimension
W	3.6~4.0
L	7.8~8.6
D	2.3~3.5

HIGH POWER CHIP RESISTORS CP12 SERIES
GENERAL ELECTRONICAL CHARACTERISTICS

Item	Unit	Symbol	Characteristic	Condition
Product Name		CRCP	High power Chip Resistors	
Size		12	CP12 Series, L6.30*W3.10*H0.60mm	
Resistance Range	Ω		68K	
Resistance Tolerance	%	J	+/-5	
TCR	0.02 ~ 0.043Ω	ppm/°C	≤±200	
	0.047 ~ 0.0976Ω		≤±150	
	0.1 ~ 0.43Ω		≤±100	
	0.47 ~ 0.976Ω		≤±100	
	1~ 10Ω		≤±100	
	≥10Ω		≤±100	
Max. Dissipation	W		2	@ Tamb=70°C
Operating Temperature	°C		-55 ~+155	
Max. Operation Voltage	V		300	@DC or RMS
Max. Overload Voltage	V		500	@DC or RMS

Note

1) This is the maximum voltage that may be continuously supplied to the resistor element, see "IEC publication 60115-8"

2) Max. Operation Voltage : So called RCWV (Rated Continuous Working Voltage) is determined by

$$RCWV = \sqrt{\text{Rated Power} \times \text{Resistance Value}} \text{ or Max. RCWV listed above, whichever is lower.}$$

3) Test condition for jumper (0 Ω)

Item	Unit	Symbol	Characteristic	Condition
Power Rating At 70°C	W		2	
Max. Resistance	mΩ		20	
Rated Current	A		10	
Peak Current	A		25	
Operating Temperature	°C		-55 ~+155	

HIGH POWER CHIP RESISTORS CP12 SERIES

PRODUCT CHARACTERIZATION

Standard values of nominal resistance are taken from the E24 & E96 series for resistors with a tolerance of $\pm 0.1\%$, $\pm 0.5\%$, $\pm 1\%$ & $\pm 5\%$. The values of the E24/E96 series are in accordance with "IEC publication 60063"

DERATING

The power that the resistor can dissipate depends on the operating temperature; see Fig.1

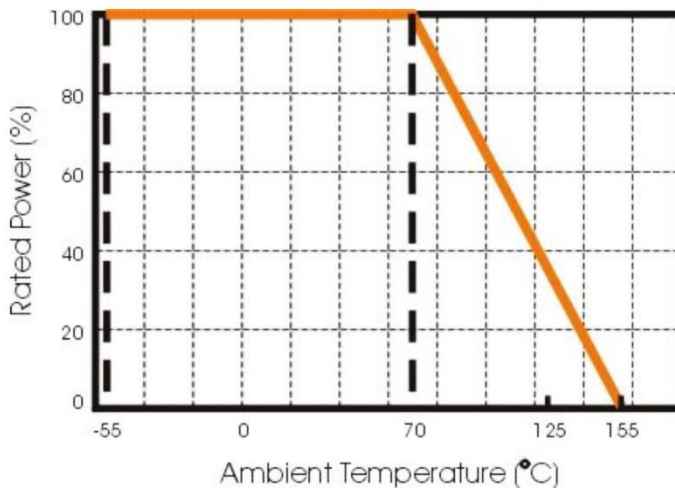

Fig 1 Maximum dissipation in percentage of rated power as a function of the ambient temperature

MOUNTING

Due to their rectangular shapes and small tolerances, Surface Mountable Resistors are suitable for handling by automatic placement systems. Chip placement can be on ceramic substrates and printed-circuit boards (PCBs). Electrical connection to the circuit is by individual soldering condition. The end terminations guarantee a reliable contact.

HIGH POWER CHIP RESISTORS CP12 SERIES

REFLOW SOLDERING CONDITION

The robust construction of chip resistors allows them to be completely immersed in a solder bath of 260 °C for 10 seconds. Therefore, it is possible to mount Surface Mount Resistors on one side of a PCB and other discrete components on the reverse (mixed PCBs). Surface Mount Resistors are tested for solderability at 235 °C during 2 seconds. The test condition for no leaching is 260°C for 30 seconds. Typical examples of soldering processes that provide reliable joints without any damage are given in Fig 2.

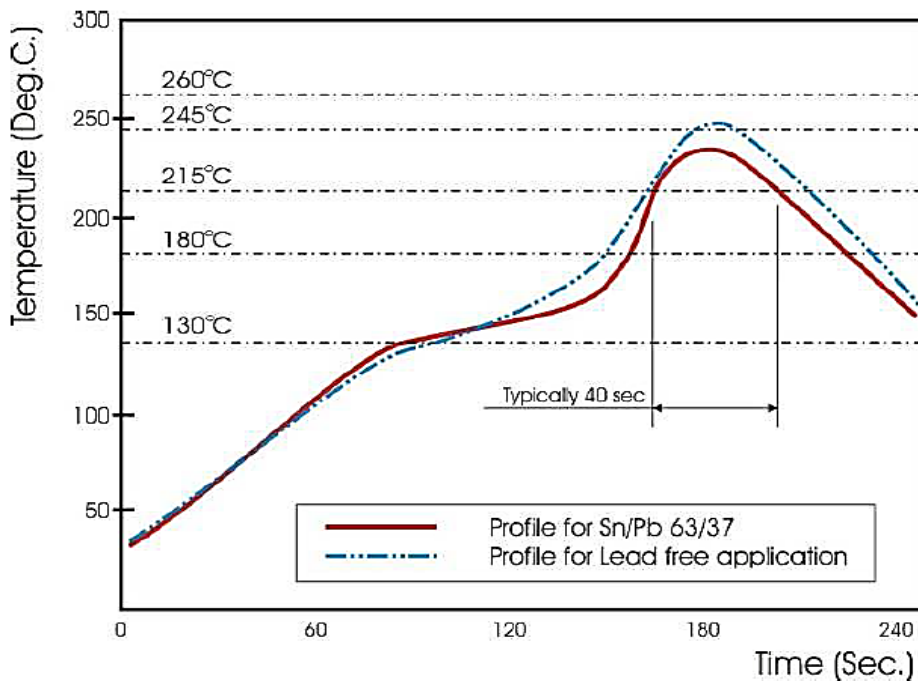

Fig 2. Infrared soldering profile for Chip Resistors

HiGH POWER CHIP RESISTORS CP12 SERIES
TEST AND REQUIREMENT (JIS C 5201-1 : 1998)

TEST	PROCEDURE / TEST METHOD	REQUIREMENT
Temperature Coefficient of Resistance(T.C.R) Clause 4.8	Natural resistance change per change in degree centigrade. $\frac{R_2 - R_1}{R_1(t_2 - t_1)} \times 10^6 \text{ (ppm/}^\circ\text{C)}$ t1 : 20°C+5°C-1°C R1 : Resistance at reference temperature R2: Resistance at test temperature	Refer to quick reference data for T.C.R specification
Short time overload (S.T.O.L) Clause 4.13	5.0× Rated power or Max. Overload Voltage for 5 sec. Measure resistance after 30 minutes..	$\Delta R/R \text{ max. } J: \leq \pm(2\%+0.1\Omega)$ B,D, F: $\leq \pm(1\%+0.05\Omega)$
Resistance to soldering heat(R.S.H) Clause 4.18	Un-mounted chips completely immersed for 10±1second in a SAC solder bath at 260°C±5°C	$\Delta R/R \text{ max. } J: \leq \pm(1\%+0.1\Omega)$ B,D, F: $\leq \pm(0.5\%+0.05\Omega)$ No visible damage
Solderability Clause 4.17	Un-mounted chips completely immersed for 2±0.5 second in a SAC solder bath at 235°C±5°C	Good tinning (>95% covered) No visible damage
Clause 4.18 Leach Test	Un-mounted chips completely immersed for 60±1second in a solder bath at 260°C±5°C	Ditto
Temperature cycling Clause 4.19	30 minutes at -55°C±3°C, 2~3 minutes at 20°C+5°C-1°C, 30 minutes at +155°C±3°C, 2~3 minutes at 20°C+5°C-1°C, total 5 continuous cycles	$\Delta R/R \text{ max. } J: \leq \pm(1\%+0.1\Omega)$ B,D,F: $\leq \pm(0.5\%+0.05\Omega)$ No visible damage
Damp Heat (Load life in humidity) Clause 4.24	1000 +48/-0 hours, loaded with RCWV or Vmax in humidity chamber controller at 40°C±2°C and 90~95% relative humidity, 1.5hours on and 0.5 hours off	$\Delta R/R \text{ max. } J: \leq \pm(3\%+0.1\Omega)$ B,D,F: $\leq \pm(1\%+0.05\Omega)$ No visible damage
Load life (endurance) JISC5201-1: 1998 Clause 4.25	1000 +48/-0 hours, loaded with RCWV or Vmax in chamber controller 70±2°C, 1.5 hours on and 0.5 Hours off	$\Delta R/R \text{ max. } J: \leq \pm(3\%+0.1\Omega)$ B,D,F: $\leq \pm(1\%+0.05\Omega)$ No visible damage
Bending strength Clause 4.33	Resistors mounted on a 90mm glass epoxy resin PCB(FR4); bending : 2 mm(2512;2010) 3mm(1206), once for 10 seconds	$\Delta R/R \text{ max. } J: \leq \pm(1\%+0.1\Omega)$ B,D,F: $\leq \pm(0.5\%+0.05\Omega)$ No visible damage

HiGH POWER CHIP RESISTORS CP12 SERIES

TEST AND REQUIREMENT (JIS C 5201-1 : 1998)

TEST	PROCEDURE / TEST METHOD	REQUIREMENT
Adhesion Clause 4.32	Pressurizing force: 5N, Test time: 10±1sec.	No remarkable damage or removal of the terminations
Insulation Resistance Clause 4.6	Apply the maximum overload voltage (DC) for 1minute	$R \geq 10G\Omega$
Dielectric Withstand Voltage Clause 4.7	Apply the maximum overload voltage (AC) for 1 minute	No breakdown or flashover

STORAGE AND HANDLING CONDITIONS

- 1) Products are recommended to be used up within two years since operation date as ensured shelf life. Check solderability in case shelf life extension is needed.
- 2) To store products with following condition: Temperature : 5 to 40°C Humidity: 20 to 70% relative humidity
- 3) Don't store products in a corrosive environment such as sulfide, chloride gas, or acid. It may cause oxidization of electrode, which easily be resulted in poor soldering b.To store products on the shelf and avoid exposure to moisture. Don't expose products to excessive shock, vibration, direct sunlight and so on.

HiGH POWER CHIP RESISTORS CP12 SERIES

REEL DIMENSION (Unit: mm)

7": 4,000Ppcs/Reel

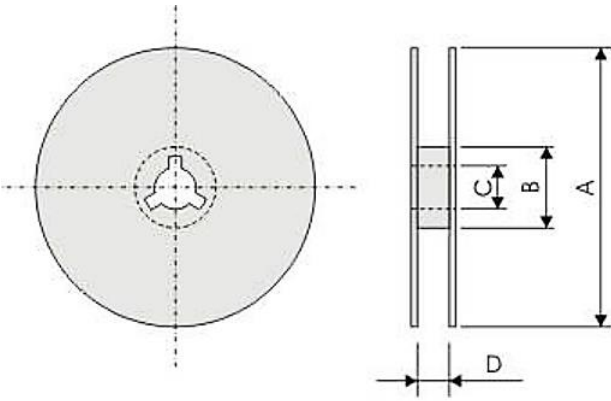

Code	Dimension 7"	Dimension 10"	Dimension 13"
A	178.0+/-2.0	254.0+/-2.0	330.0+/-2.0
B	60.0 +/--1.0	100 +/--1.0	100+/--1.0
C	13.0+/-0.20	13.0+/-0.20	13.0+/-0.20
D	12.4±1.0	12.4±1.0	12.4±1.0

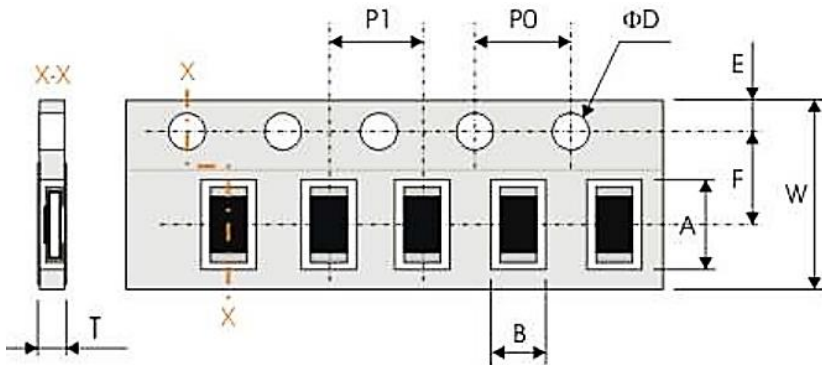
TAPE DIMENSION (Unit: mm)

Code	Dimension
A	6.90±0.20
B	3.60±0.20
W	12.0±0.30
F	5.50±0.10
E	1.75±0.10
P 1	4.00±0.10
P0	4.00±0.10
ΦD	1.50±0.10
T	1.2 Max.

TAPING QUANTITY AND TAPE MATERIAL

Tape	Paper Tape						Embossed Tape	Bulk Cassette
	4 mm Pitch			2 mm Pitch			4 mm Pitch	
Reel Size	7"	10"	13"	7"	10"	13"	7"	
CP12	4000	10000	20000	-	-	-	-	5000

HIGH POWER CHIP RESISTORS CP12 SERIES

PERFORMANCE OF TAPING

Strength of Carrier Tape and Top Cover Tape

Carrier Tape: When a tensile force 1.02kgf is applied in the direction of unreeling the tape, the tape shall withstand this force. Top cover Tape: When a tensile force 1.02kgf is applied to the tape, the tape shall withstand this force.

Peel Force of Top Cover Tape

Unless otherwise specified, the peel force of top cover tape shall be 10.2 to 71.4 g f when the top cover tape is pulled at a speed of 300mm/min with the angle between the taped during peel and the direction of unreeling maintained at 165 to 180° as illustrated in Fig.

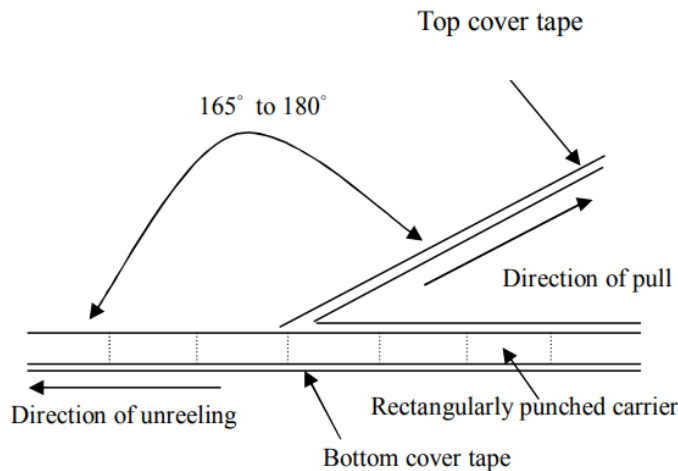

DISCLAIMER

NextGen Component, Inc. reserves the right to make changes to the product(s) and or information contained herein without notice. No liability is assumed as a result of their use or application. No rights under any patent accompany the sale of any such product(s) or information