



SPECIFICATION SHEET

SPECIFICATION SHEET NO.	Q0602- CR0805FB10KS01
DATE	June. 2, 2023
REVISION	A0
DESCRIPTION	<p>Thick Film Chip Resistors, 0805 (2012 Metric), CR05 Series, Dimension L2.00*W1.25*H0.50mm, 2 Terminations Tolerance: ±1.0%, Resistance 10K ohm, Dissipation Max. 1/8W @ 70°C Temperature Coefficient Rate (TCR) Max. ±100ppm/°C Operating Temp. Range -55°C ~+155°C Package in Tape/Reel, 5,000pcs/Reel RoHS/RoHS III compliant and HF</p>
CUSTOMER	
CUSTOMER PART NUMBER	
CROSS REF. PART NUMBER	
ORIGINAL PART NUMBER	Aillen CR05FB10K
PART CODE	CR0805FB10KS01

VENDOR APPROVE			
Issued/Checked/Approved			
DATE: June. 2, 2023			

CUSTOMER APPROVE	
DATE:	

6/2/2023

THICK FILM CHIP RESISTORS CR05 SERIES

DESCRIPTION

The resistors are constructed in a high grade ceramic body (aluminum oxide). Internal metal electrodes are added at each end and connected by a resistive paste that is applied to the top surface of the substrate. The composition of the paste is adjusted to give the approximate resistance required and the value is trimmed to within tolerance by laser cutting of this resistive layer. The resistive layer is covered with a protective coat. Finally, the two external end terminations are added. For ease of soldering the outer layer of these end terminations is a Tin (lead free) alloy.



MAIN FEATURE

- High Reliability And Stability
- Reduced Size Of Final Equipment
- Lower Assembly Costs
- Higher Component And Equipment Reliability
- RoHS III Compliant And Halogen Free Products

APPLICATION

- Consumer Electrical Equipment
- EDP, Computer Application
- Telecom Application

RFQ

[Request For Quotation](#)

PART CODE GUIDE

CR	0805	F	B	10K	S01
1	2	3	4	5	6

- 1) **CR**: Product code for Thick Film Chip Resistors
- 2) **0805**: Size Code, 0805 (2012 Metric), CR05 Series, Dimensions L2.00*W1.25*H0.50mm
- 3) **F**: Resistance Range Tolerance Code, P: Jumper; B: +/-0.1%; D: +/-0.5%; F: +/-1%; J: +/-5%
- 4) **B**: Package Code, A: 4Kpcs/7"Reel; B:5kpcs/7"Reel; C:10kpcs/7"Reel; M:15kpcs/7"Reel; D:10kpcs/10"Reel; E:20kpcs/10"Reel
- 5) **10K**: Resistance value code. 0R: 0ohm; 1R2: 1.2ohm; 10R: 10ohm; 20R: 20ohm; 39R: 39ohm; 120R: 120ohm; 680R: 680ohm
1K: 1Kohm; 3K3: 3.3Kohm; 8K2: 8.2Kohm; 10K: 10 Kohm; 47K: 47Kohm; 100K: 100Kohm; 300K: 300Kohm; 1M: 1.0Mohm; 3M: 3.0Mohm
- 6) **S01**: Internal control code, digits and letter; Blank: N/A

THICK FILM CHIP RESISTORS CR05 SERIES

DIMENSION (Unit: mm)

Image for reference



General Marking:

Tolerance $\pm 1\%$: 4-digits marking

Tolerance $\pm 5\%$: 3-digits marking

*Each resistor is marked with a three digits code on the protective coating to designate the nominal resistance value

CR05 series

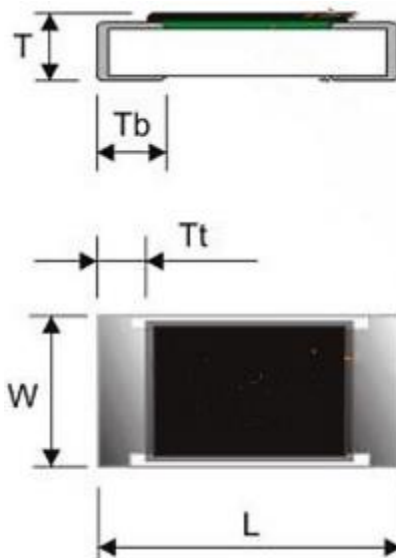

Item	Dimension
L	2.00 \pm 0.10
W	1.25 \pm 0.10
T	0.50 \pm 0.15
T b	0.40 \pm 0.20
T t	0.40 \pm 0.20

Resistors Construction For Reference



Recommended Solder Pad

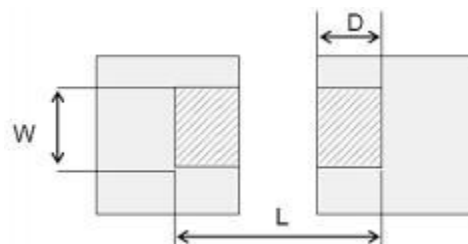

Item	Dimension
W	1.00~1.40
L	3.20~3.80
D	0.90~1.40

THICK FILM CHIP RESISTORS CR05 SERIES
GENERAL ELECTRONICAL CHARACTERISTICS

Item		Unit	Symbol	Characteristic	Condition
Product Name			CR	Thick Film Chip Resistors	
Size			0805	CR05 Series, L2.00*W1.25*H0.50mm	
Resistance Range		Ω		10K	
Resistance Tolerance		%	F	+/-1	
TCR	10MΩ≥ R>10Ω	ppm/°C		≤±100	
	R≤10Ω			-200~+400	
Max. Dissipation		W		1/8	@ Tamb=70°C
Operating Temperature		°C		-55 ~+155	
Max. Operation Voltage		V		150	@DC or RMS
Max. Overload Voltage		V		300	@DC or RMS

Note

- 1) This is the maximum voltage that may be continuously supplied to the resistor element, see "IEC publication 60115-8"
- 2) Max. Operation Voltage : So called RCWV (Rated Continuous Working Voltage) is determined by

$$RCWV = \sqrt{\text{Rated Power} \times \text{Resistance Value}}$$
or Max. RCWV listed above, whichever is lower.
- 3) Test condition for jumper (0 Ω)

Item	Unit	Symbol	Characteristic	Condition
Power Rating At 70°C	W		1/8	
Max. Resistance	mΩ		50	
Rated Current	A		1.5	
Peak Current	A		3.5	
Operating Temperature	°C		-55 ~+155	

THICK FILM CHIP RESISTORS CR05 SERIES

PRODUCT CHARACTERIZATION

Standard values of nominal resistance are taken from the E24 & E96 series for resistors with a tolerance of +/-1% & +/-5%. The values of the E24/E96 series are in accordance with "IEC publication 60063"

DERATING

The power that the resistor can dissipate depends on the operating temperature; see Fig.1

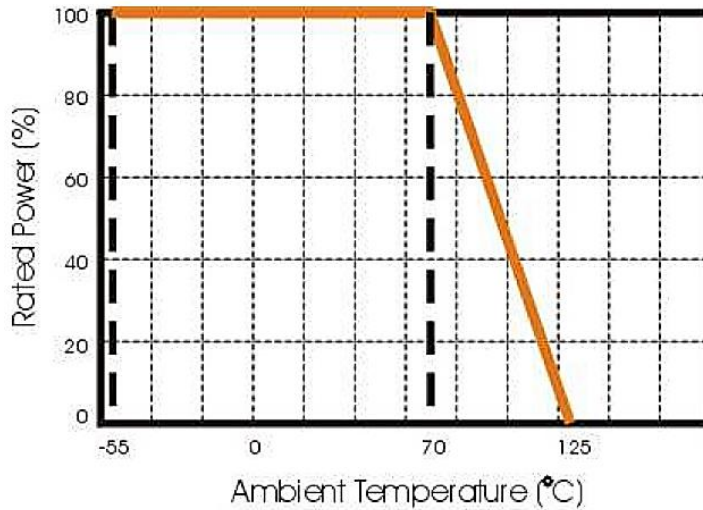

Fig 1 Maximum dissipation in percentage of rated power as a function of the ambient temperature for CR0805

MOUNTING

Due to their rectangular shapes and small tolerances, Surface Mountable Resistors are suitable for handling by automatic placement systems. Chip placement can be on ceramic substrates and printed-circuit boards (PCBs). Electrical connection to the circuit is by individual soldering condition. The end terminations guarantee a reliable contact.

THICK FILM CHIP RESISTORS CR05 SERIES

REFLOW SOLDERING CONDITION

The robust construction of chip resistors allows them to be completely immersed in a solder bath of 260 °C for 10 seconds. Therefore, it is possible to mount Surface Mount Resistors on one side of a PCB and other discrete components on the reverse (mixed PCBs). Surface Mount Resistors are tested for solderability at 235 °C during 2 seconds. The test condition for no leaching is 260°C for 30 seconds. Typical examples of soldering processes that provide reliable joints without any damage are given in Fig 2.

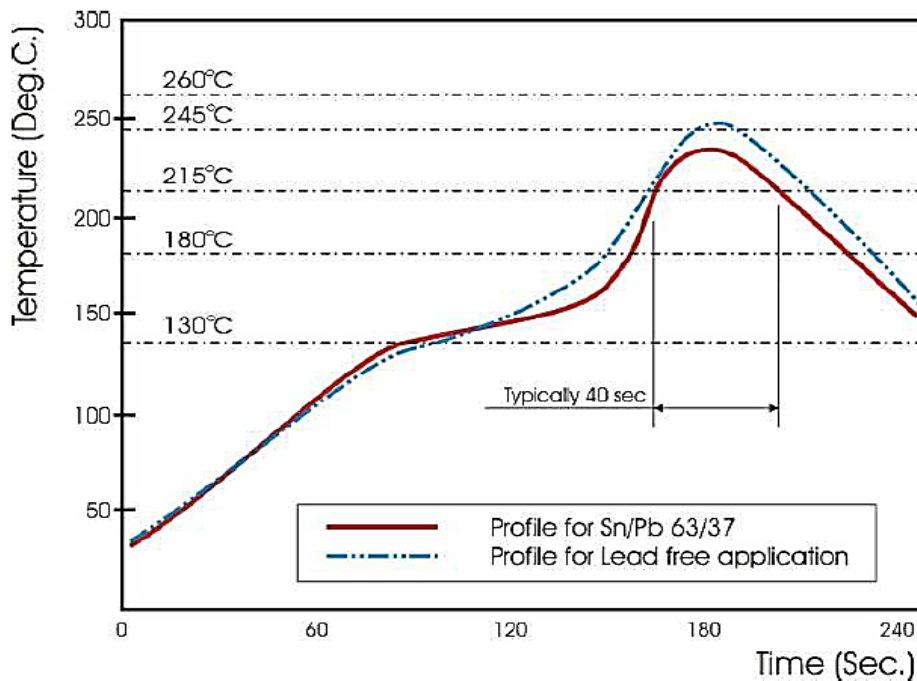

Fig 2. Infrared soldering profile for Chip Resistors

THICK FILM CHIP RESISTORS CR05 SERIES
TEST AND REQUIREMENT (JIS C 5201-1 : 1998)

TEST	PROCEDURE / TEST METHOD	REQUIREMENT	
		Resistor	Ω
Electrical Characteristics JIS C 5201-1: 1998 Clause 4.8	- DC resistance values measurement - Temperature Coefficient of Resistance (T.C.R) Natural resistance change per change in degree centigrade. $\frac{R_2 - R_1}{R_1(t_2 - t_1)} \times 10^6 \text{ (ppm/}^\circ\text{C)}$ t1 : 20°C+5°C-1°C; t2 : -55°C or +155°C R1 : Resistance at reference temperature (20°C+5°C/- 1°C) R2: Resistance at test temperature (-55°C or +155°C)	Within the specified tolerance Refer to “QUICK REFERENCE DATA”	<50mΩ
Resistance To Soldering Heat(R.S.H) JIS C 5201-1:1998 Clause 4.18	Un-mounted chips completely immersed for 10±1 second in a SAC solder bath at 260°C±5°C	±5%: ΔR/R max. ±(1%+0.05Ω); ±1%: ΔR/R max. ±(0.5%+0.05Ω) no visible damage	<50mΩ
Solderability JIS C 5201-1: 1998 Clause 4.17	Un-mounted chips completely immersed for 2±0.5 second in a SAC solder bath at 235°C±5°C	95% coverage min., good tinning and no visible damage	
Temperature cycling JIS C 5201-1: 1998 Clause 4.19	30 minutes at -55°C±3°C, 2~3 minutes at 20°C+5°C-1°C, 30 minutes at +125°C±3°C, 2~3 minutes at 20°C+5°C-1°C, total 5 continuous cycles	±5%: ΔR/R max. ±(1%+0.05Ω); ±1%: ΔR/R max. ±(0.5%+0.05Ω) no visible damage	<50mΩ
High Temperature Exposure MIL-STD-202 method 108	1000+48/-0 hours; without load in a temperature chamber controlled 155 ± 3 C	±5%: ΔR/R max. ±(2%+0.1Ω); ±1%: ΔR/R max. ±(1%+0.1Ω) no visible damage	<50mΩ

THICK FILM CHIP RESISTORS CR05 SERIES
TEST AND REQUIREMENT (JIS C 5201-1 : 1998)

TEST	PROCEDURE / TEST METHOD	REQUIREMENT	
		Resistor	Ω
Bending strength JISC5201-1: 1998 Clause 4.33	Resistors mounted on a 90mm glass epoxy resin PCB(FR4), bending once 3mm for 10sec, 5mm for CR05	±5%: ΔR/R max. ±(1%+0.05Ω); ±1%: ΔR/R max. ±(1%+0.05Ω) no visible damage	<50mΩ
Adhesion JISC5201-1: 1998 Clause 4.32	Pressurizing force: 5N, Test time: 10±1sec	No remarkable damage or removal of the terminations	
Short Time Overload (STOL) JISC5201-1: 1998 Clause 4.13	2.5 times RCWV or max. overload voltage, for 5seconds	±5%: ΔR/R max. ±(2%+0.05Ω); ±1%: ΔR/R max. ±(1%+0.05Ω) no visible damage	<50mΩ
Load life in Humidity JISC5201-1: 1998 Clause 4.24	1000 +48/-0 hours, loaded with RCWV or Vmax in humidity chamber controller at 40 C 2 C and 90~95% relative humidity, 1.5hours on and 0.5 hours off	±5%: ΔR/R max. ±(2%+0.1Ω); ±1%: ΔR/R max. ±(1%+0.1Ω) no visible damage	<50mΩ
Load life (endurance) JISC5201-1: 1998 Clause 4.25	1000 +48/-0 hours, loaded with RCWV or Vmax in chamber controller 70±2°C, 1.5 hours on and 0.5 Hours off	±5%: ΔR/R max. ±(3%+0.1Ω); ±1%: ΔR/R max. ±(1%+0.1Ω) no visible damage	<50mΩ
Insulation Resistance JISC5201-1: 1998 Clause 4.6	Apply the maximum overload voltage (DC) for 1minute	R ≥ 10GΩ	
Dielectric Withstand Voltage JISC5201-1: 1998 Clause 4.7	Apply the maximum overload voltage (AC) for 1 minute	No breakdown or flashover	

THICK FILM CHIP RESISTORS CR05 SERIES
REEL DIMENSION (Unit: mm)

7": 5,000Ppcs/Reel

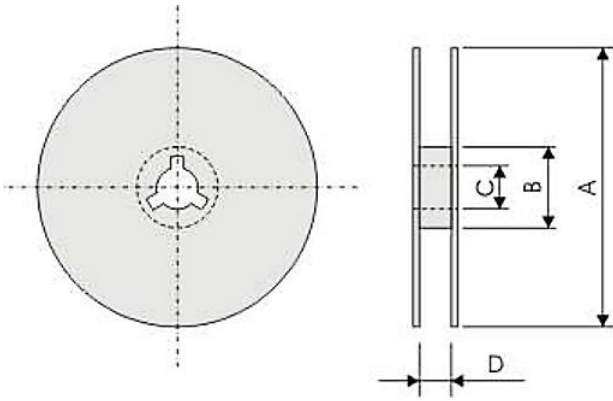

Code	Dimension 7"	Dimension 10"	Dimension 13"
A	178.0+/-2.0	254.0+/-2.0	330.0+/-2.0
B	60.0 +/-1.0	100 +/-1.0	100+/-1.0
C	13.0+/-0.20	13.0+/-0.20	13.0+/-0.20
T	9.0+/-0.50	9.0+/-0.5	9.0+/-0.5

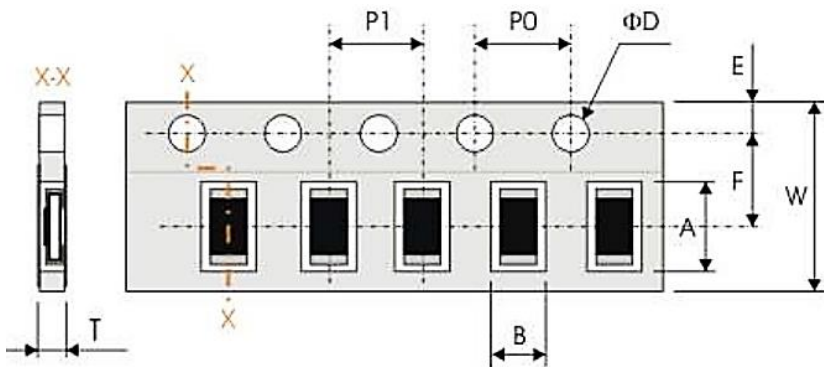
TAPE DIMENSION (Unit: mm)

Code	Dimension
A	2.40±0.20
B	1.65±0.20
W	8.00±0.30
F	3.50±0.20
E	1.75±0.10
P 1	4.00±0.10
P0	4.00±0.10
ΦD	1.50+0.10/-0.0
T	1.0 Max.

TAPING QUANTITY AND TAPE MATERIAL

Tape	Paper Tape						Embossed Tape	Bulk Cassette
	4 mm Pitch			2 mm Pitch			4 mm Pitch	
Reel Size	7"	10"	13"	7"	10"	13"	7"	
CR05	5000	10000	20000	-	-	-	-	10000

THICK FILM CHIP RESISTORS CR05 SERIES

PERFORMANCE OF TAPING

Strength of Carrier Tape and Top Cover Tape

Carrier Tape: When a tensile force 1.02kgf is applied in the direction of unreeling the tape, the tape shall withstand this force. Top cover Tape: When a tensile force 1.02kgf is applied to the tape, the tape shall withstand this force.

Peel Force of Top Cover Tape

Unless otherwise specified, the peel force of top cover tape shall be 10.2 to 71.4 g f when the top cover tape is pulled at a speed of 300mm/min with the angle between the taped during peel and the direction of unreeling maintained at 165 to 180° as illustrated in Fig.

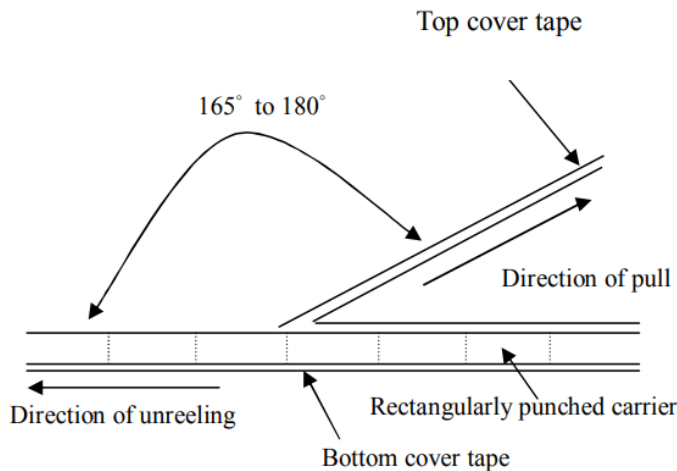

DISCLAIMER

NextGen Component, Inc. reserves the right to make changes to the product(s) and or information contained herein without notice. No liability is assumed as a result of their use or application. No rights under any patent accompany the sale of any such product(s) or information